

# SURGIXA



Instrumentation

**Address: Circular Road Main Bazar Sialkot, Punjab, Pakistan.  
Mail: [info@surgixa.com](mailto:info@surgixa.com)**

# Plastic Surgery

**Retractors & Hooks**

1 - 14



**Dissectors**

15 - 24



**Markers & Calipers**

25 - 30



**Curettes, Chisels, Osteotomes**

31 - 38



**Ear, Nose & Throat**

39 - 46



**Bone Instruments**

47 - 52

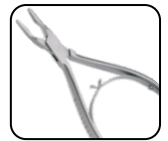

**Scissors**

53 - 64



**Thumb & Tissue Forceps**

65 - 72



**Haemostatic Forceps & Clamps**

73 - 78





# Plastic Surgery

**Needle Holders**

79 - 84

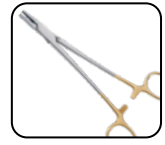

**General Instruments**

85 - 90



**Liposuction Cannulas**

91 - 98



**Headlight & Cables**

99 - 102



**New Arrivals**

103 - 108

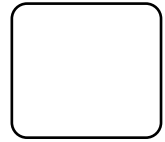

**Sterilization & Maintenance**

109 - 112



**Alphabetical Index**

113 - 116

**A - Z**

**Numerical Index**

117 - 120

**0 - 9**

**Fiberoptic Retractors**

2 - 6



**General Retractors**

7



**Rake Retractors**

8 - 11



**Nasal Retractors**

11



**Skin Hooks**

12 - 13



14



# Fiber Optic Retractors

Mammoplastic Retractors

# SURGIXA

## TEBBETTS Style Retractors

with serrated tip

With Light Guide	With Light Guide & Suction	With Suction	Retractor Only	With Light Guide & Suction W/O Teeth	Blades
572-1009	572-1042				10 mm x 13 cm
572-1010	572-1011	572-10102	572-10101		16 mm x 8 cm
	572-1096				16 mm x 13 cm
572-1012	572-1013	572-10122	572-10121		16 mm x 18 cm
572-1020	572-1021	572-10202	572-10201	572-10219	24 mm x 9 cm
572-1022	572-1023	572-10222	572-10221		24 mm x 10 cm
572-1024	572-1025	572-10242	572-10241		25 mm x 10 cm
572-1026	572-1027	572-10262	572-10261		25 mm x 12 cm
572-1028	572-1029	572-10282	572-10281		25 mm x 15 cm
572-10190	572-1019	572-10192	572-10191	572-10199	25 mm x 18 cm
572-10180	572-1018	572-10182	572-10181		25 mm x 20 cm
572-1030	572-1031	572-10302	572-10301	572-10319	30 mm x 9 cm
572-1032	572-1033	572-10322	572-10321		30 mm x 12 cm
572-1034	572-1035	572-10342	572-10341	572-10359	30 mm x 15 cm
572-1036	572-1037	572-10362	572-10361	572-10379	30 mm x 19 cm
572-1040	572-1041	572-10402	572-10401		36 mm x 16 cm
572-1050	572-1051	572-10502	572-10501		36 mm x 19 cm



## FERRIERA Style Retractors

with smooth tip

With Light Guide	With Light Guide & Suction	with Suction	Retractor Only	Blades
572-1056	572-1057	572-10562	572-10561	14 mm x 7 cm
572-1058	572-1059	572-10582	572-10581	14 mm x 9 cm
572-1060	572-1061	572-10602	572-10601	16 mm x 8 cm
572-1062	572-1063	572-10622	572-10621	16 mm x 15 cm
572-1064	572-1065	572-10642	572-10641	23 mm x 10 cm
572-1066	572-1067	572-10662	572-10661	23 mm x 15 cm
572-1068	572-1069	572-10682	572-10681	23 mm x 18 cm
572-1079		572-10792	572-10791	25 mm x 8 cm
572-1082	572-1083	572-10822	572-10821	25 mm x 10 cm
572-1084	572-1085	572-10842	572-10841	25 mm x 12 cm
572-1086	572-1087	572-10862	572-10861	25 mm x 15 cm
	572-1088			25 mm x 18 cm
572-1080	572-1081	572-10802	572-10801	25 mm x 19 cm
572-1078	572-1093			27 mm x 22 cm
572-1070	572-1071	572-10702	572-10701	30 mm x 12 cm
572-1072	572-1073	572-10722	572-10721	30 mm x 15 cm
572-1074	572-1075	572-10742	572-10741	30 mm x 18 cm
572-1076	572-1077	572-10762	572-10761	30 mm x 19 cm

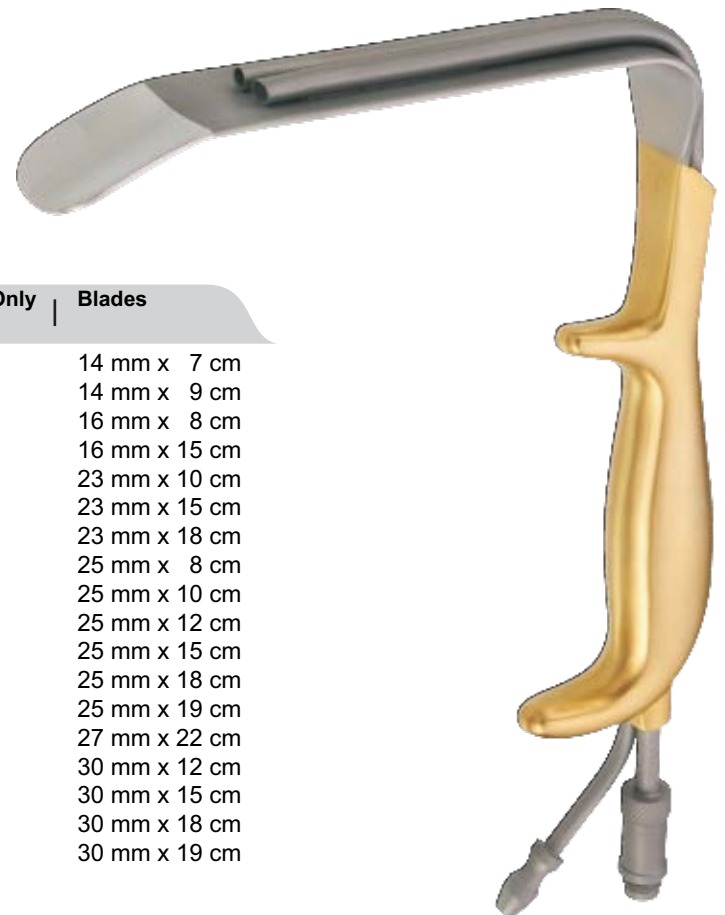

### BIGGS Mammoplasty Retractors

With Light Guide	With Light Guide & Suction	Retractor Only	Blades Width
572-1100	572-1110	572-1120	30 mm
572-1101	572-1111	572-1121	50 mm

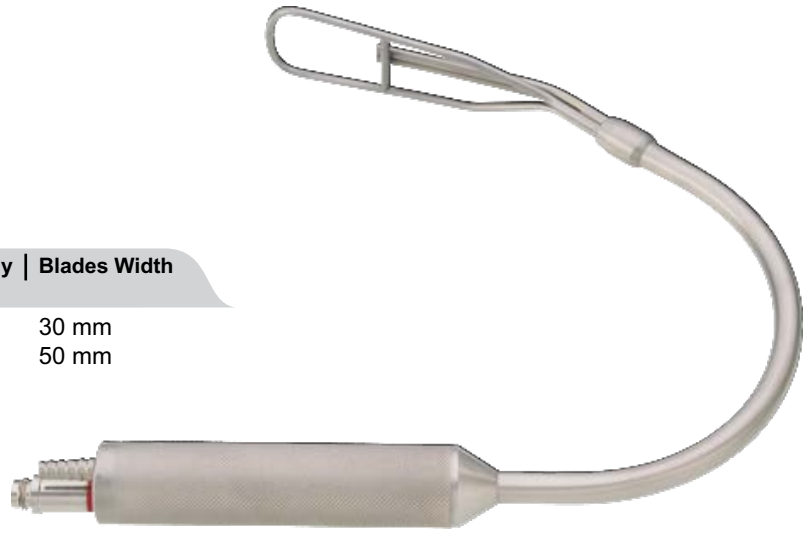

### BIGGS Face Lift Retractors

Length 9" (23 cm)

With Light Guide	Retractor Only	Blades
572-1115	572-1105	50 mm



### EMORY Style Retractors

for 10 mm scopes

With Suction	Without Suction	Blades width & Length
572-1190		1" x 4 <sup>3</sup> / <sub>4</sub> " (25.4 mm x 120.7 mm)
572-1191		1" x 10" (25.4 mm x 254 mm)
	572-1192	9/16" x 4 <sup>3</sup> / <sub>4</sub> " (14.3 mm x 120.7 mm)

for 5 mm scopes

With Suction	Without Suction	Blades width & Length
	572-1193	9/16" x 4 <sup>3</sup> / <sub>4</sub> " (14.3 mm x 120.7 mm)
	572-1194	3/8" x 7" (9.5 mm x 177.8 mm)

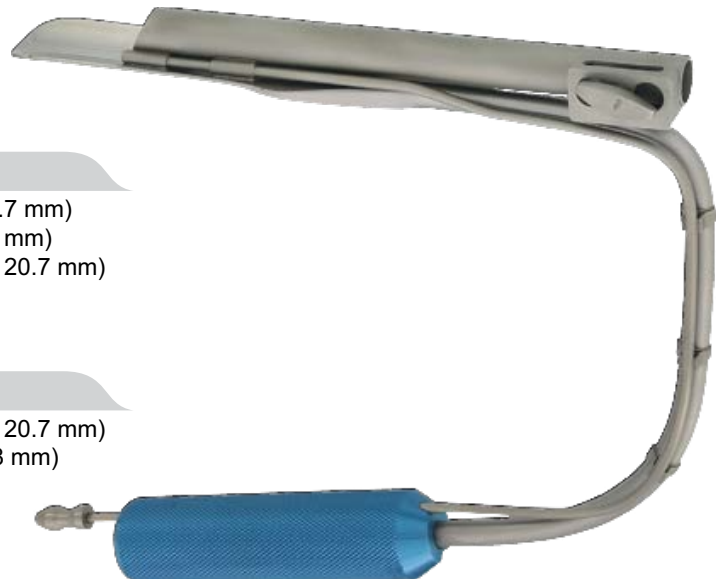



Multi Approach Retractor  
with smooth round tip

	Blades
572-1090	23 mm x 18 cm



Face-lift Retractors

With Light Guide	Without Light Guide	Blades
572-1130	572-1131	22 mm x 11 cm



WIEDER Tongue Depressors  
Serrated blade

Depressor Only	With Light Guide
548-290	572-1160
548-292	572-1162

With Light Guide & Suction	Length
572-1161	5½" (14 cm)
572-1163	6" (15 cm)

Blades  
38 mm, Small  
45 mm, Large



AUFRICHT Nasal Retractors

With Light Guide	With Light Guide & Suction	Retractor Only	Suction Only	Blades	Length
572-1000	572-1006	572-1001	572-0091	7 x 45 mm	6¼" (16 cm)
572-1004	572-1008	572-1005	572-0092	7 x 45 mm	7" (18 cm)
572-1002	572-1007	572-1003	572-0093	10 x 45 mm	7" (18 cm)

Fenestrated blades

With Light Guide	Retractor Only	Blade	Length
572-10001	572-10011	45 mm	7" (18 cm)

**MALINIAC Nasal Retractors**

With Light Guide	Without Light Guide	Blades	Length
572-1140	572-1139	9 x 45 mm	4" (10 cm)



**CONVERSE Nasal Retractors**

Length 3½" (9 cm)

With Light Guide	Without Light Guide	Blades
572-1142	572-1146	10 x 20 mm
572-1143	572-1147	12 x 30 mm
572-1144	572-1148	12 x 40 mm
572-1145	572-1149	12 x 50 mm



**FREEMAN Flap Retractors**

With Light Guide	Without Light Guide	Blades	Length
572-1152	572-1153	12 mm	8" (20 cm)
572-1154	572-1155	25 mm	8" (20 cm)



**HARRINGTON Retractors**

Length 12½" (32 cm)

With Light Guide	With Light Guide & Suction	Retractor Only	Blades
518-5150	518-5151	518-150	40 x 127 mm
518-5152	518-5153	518-152	62 x 127 mm

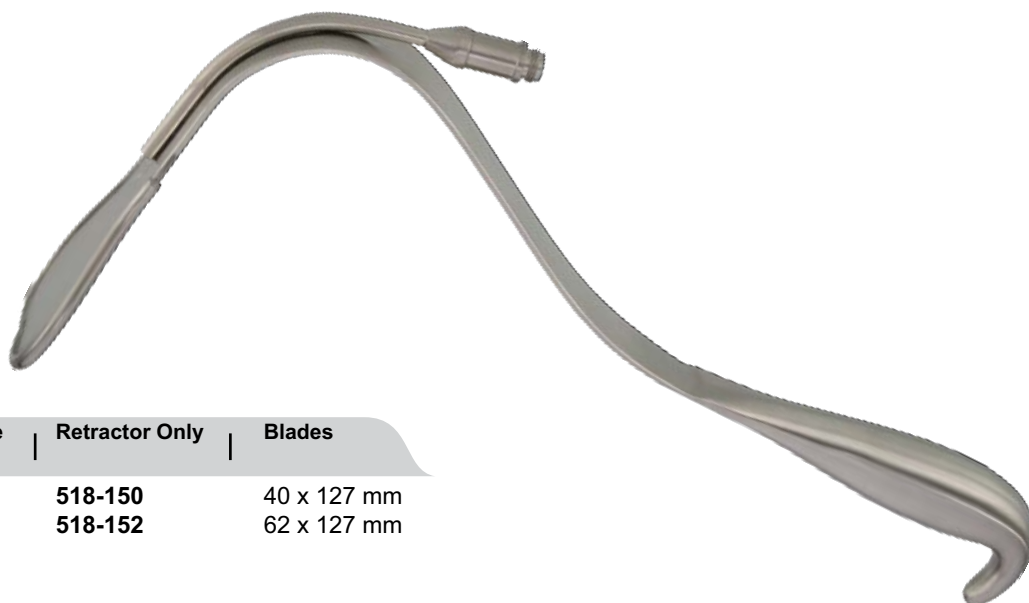



**DEAVER Retractors**

With Light Guide	Without Light Guide	Blades	Length
518-5130	518-1291	3/4" (19 mm)	7" (18 cm)
518-5133		1" (25 mm)	8" (20 cm)
518-5134	518-134	1" (25 mm)	9" (23 cm)
518-5129	518-129	5/8" (16 mm)	9" (23 cm)
518-5136	518-136	1" (25 mm)	9" (12 cm)
518-5138	518-138	1" (25 mm)	13" (33 cm)
518-5142	518-142	1 1/2" (38 mm)	12" (30 cm)
518-5144	518-144	2" (50 mm)	12" (30 cm)
518-5143	518-143	1 1/2" (38 mm)	13" (33 cm)

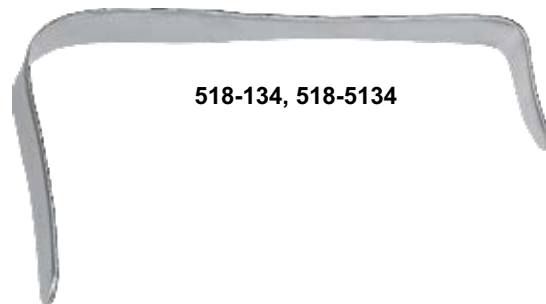

**DEAVER Pediatric Retractors**

Length 8" (20 cm), tail curved to front

With Light Guide	Blades
518-512516	5/8" (16 mm)
518-512525	1" (25 mm)



**Breast Spatulas with handle**

Length 12 1/2" (31.5 cm), semi malleable

Serrated	Smooth	Working Tip
572-1201	572-1203	1" x 6" (25 mm x 18 cm)
572-1202	572-1204	1 1/2" x 6" (38 mm x 18 cm)

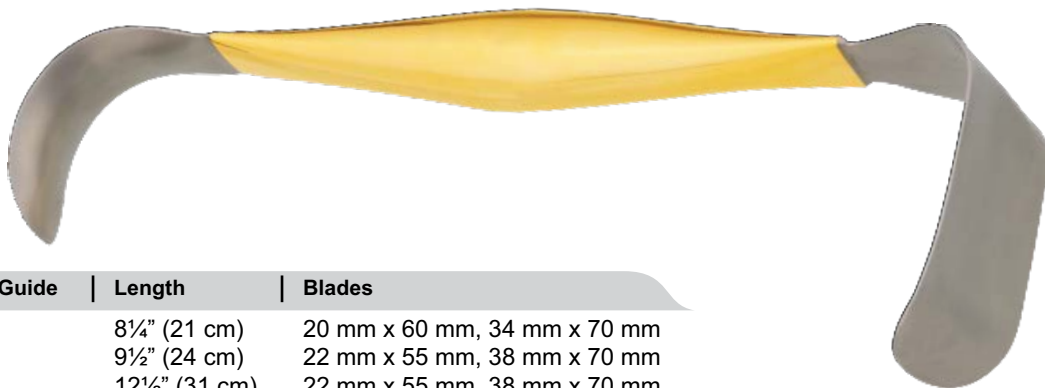

**Breast Retractors**

double ended

Retractor Only	With Light Guide	Length	Blades
572-1214		8 1/4" (21 cm)	20 mm x 60 mm, 34 mm x 70 mm
572-1212		9 1/2" (24 cm)	22 mm x 55 mm, 38 mm x 70 mm
572-1210	572-1211	12 1/2" (31 cm)	22 mm x 55 mm, 38 mm x 70 mm



## RICHARDSON-EASTMAN Retractors

double ended

	Size	Width & Depth	Blade Size
518-690	Set of 2		
518-691	10" (25.4 cm), Small	3/4" x 1 1/8" 1 1/8" x 1 1/2"	19 x 29 mm 29 x 38 mm
518-692	10 5/8" (27 cm), Large	1 1/2" x 1 3/4" 1 5/8" x 2 1/2"	38 x 45 mm 41 x 64 mm



## US ARMY (PARKER LANGENBECK) Retractors

Length 8 1/4" (21 cm), double ended

	Fig.	Blade
518-050	Set of 2	
518-051	1	21 x 24 mm / 44 x 15 mm
518-052	2	25 x 24 mm / 44 x 15 mm

## RIBBON Retractors

Malleable



	Width	Length
518-67806	6 mm	7" (18 cm)
518-67810	10 mm	7" (18 cm)
518-67813	13 mm	7" (18 cm)
518-67815	17 mm	7" (18 cm)
518-67819	19 mm	7" (18 cm)
518-67825	25 mm	7" (18 cm)
518-68219	19 mm	13" (33 cm)
518-68225	25 mm	13" (33 cm)
518-68231	32 mm	13" (33 cm)
518-68250	51 mm	13" (33 cm)
518-68275	64 mm	13" (33 cm)

## Lead Hand

for hand surgery

	Size
528-11301	14" (35 cm), for Adults
528-11302	9 1/2" (24 cm), for Children





**FREEMAN Face-Lift Retractors**

Length 7" (18 cm), with bent neck



	Blade	Prongs
<b>572-1300</b>	38 mm	4 sharp



**FREEMAN RAKE Retractors**

Length 7" (18 cm)

	Blades	Prongs
<b>572-1305</b>	19 mm	4 blunt (2 recessed)
<b>572-1306</b>	19 mm	4 sharp (2 recessed)
<b>572-1301</b>	22 mm	4 sharp
<b>572-1302</b>	22 mm	4 sharp (2 recessed)
<b>572-1303</b>	38 mm	4 sharp
<b>572-1304</b>	38 mm	4 sharp (2 recessed)

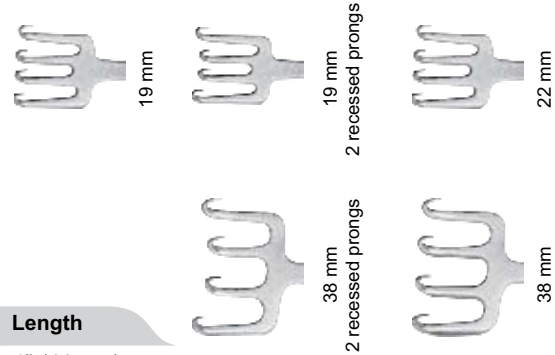

	Blades	Prongs	Length
<b>572-1314</b>	38 mm	4 sharp (2 recessed)	4" (10 cm)
<b>572-1317</b>	25 mm	4 sharp (2 recessed)	4¼" (10.8 cm)
<b>572-1308</b>	25 mm	4 sharp (in-line prongs)	4¼" (10.8 cm)
<b>572-1319</b>	25 mm	4 sharp	4¾" (12.0 cm)

**FREEMAN mini RAKE Retractors**

Length 2" (5 cm), with thumb ring

	Blades	Prongs
<b>572-1318</b>	19 mm	4 sharp
<b>572-1316</b>	38 mm	4 sharp



**FREEMAN RAKE Retractors**

Length 4" (10 cm)

	Blades
<b>572-1311</b>	22 mm
<b>572-1312</b>	38 mm



**GORNEY RAKE Retractors**

With spring neck

	Blades	Length
<b>572-1320</b>	38 mm	3" (7.5 cm)
<b>572-1321</b>	38 mm	4¼" (10.8 cm)



**MAXWELL FLAP Retractors**

Length 4" (10 cm)

	Blades
572-1331	22 mm
572-1332	38 mm



**Coronal Brow Lift Retractors**

Length 7" (18 cm), 7 prongs

	Blades Width	Grip
572-1341	70 mm	front
572-1342	70 mm	reverse

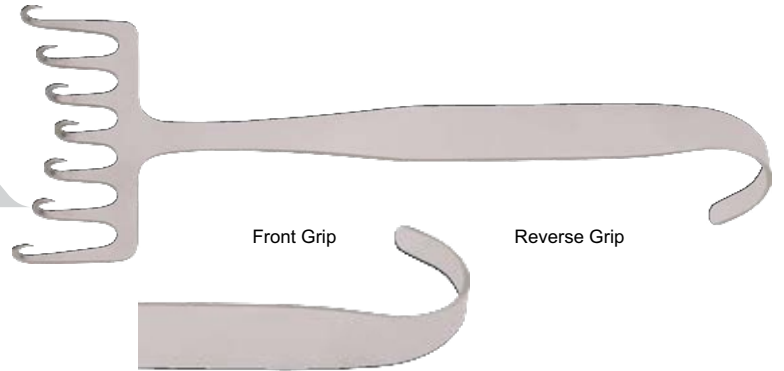

**Coronal Lift Retractor**

Length 8¼" (21 cm), 6 prongs

	Blades Width
572-1350	180 mm

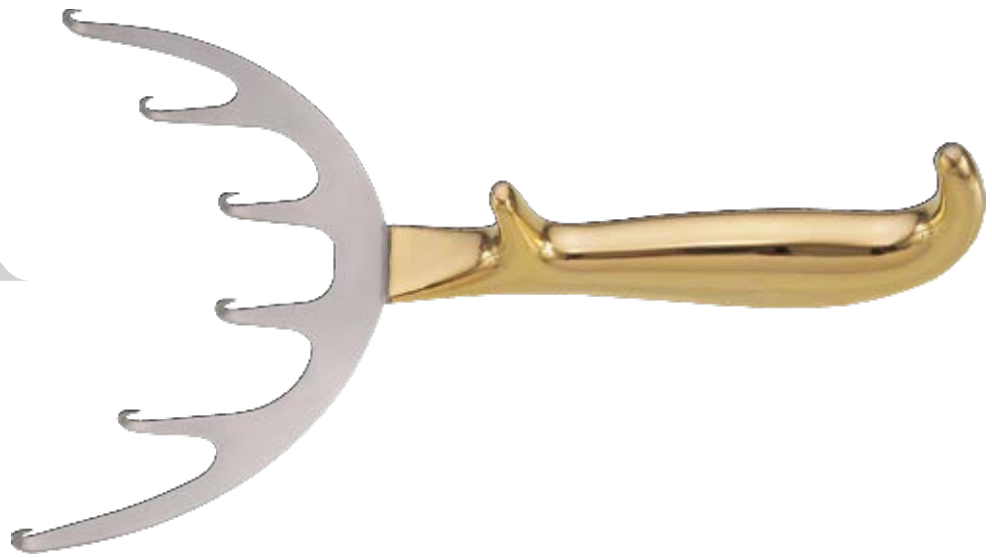

**YANCOSKIE Abdominoplasty Retractor**

Length 7½" (19 cm), 6 prongs

	Blades Width
572-1354	150 mm



**ANDERSON Bear Claw Retractors**

2 3/4" (7 cm)	4 1/2" (11 cm)	6 1/4" (16 cm)	Prongs
572-1361	572-1362	572-1363	3 sharp
572-1365	572-1366	572-1364	5 sharp



**CONVERSE Alar Retractors**

Length 4 3/4" (12 cm), double ended

	Blades
572-1372	10 mm / 14 mm sharp prongs
572-1373	10 mm / 14 mm blunt prongs



**MILLARD (ADSON) Hooks Forceps**

double hooks forceps 1 x 2 teeth, with thimble

	Length	Wide Hook
572-13810	4" (10 cm)	10 mm



**MARTINEZ KILNER Retractors**

2 sharp hooks, with thimble

	Length	Tip
572-1377	3 1/4" (8 cm)	10 mm
572-1376	4 1/4" (11.5 cm)	7.5 mm



Swivel



**Thimble Hooks**

Blade (18 mm)

Single Hook	Double Hook	
572-1335	572-1336	right handed
572-1337	572-1338	left handed



**LOGAN Bow Lip traction retractors**

Without Teeth	With Teeth	Width	Size
572-1383	572-1393	1" (25 mm)	11 cm/4 1/4"
572-1384	572-1394	1 1/4" (32 mm)	15 cm/6"
572-1385	572-1395	1 3/8" (35 mm)	18 cm/7"



**RAGNELL-DAVIS Retractor - Delicate**

Double ended, Length 6" (15 cm)

Black Ebony Finish	With Laser Coating
	518-18415LC



**RAGNELL Retractors**

Double ended

	Insulated blade	Length
518-18614		5 1/2" (14 cm)
518-18615	518-18715	6" (15 cm)



# Retractors

Rake Retractors, Nasal Retractors

# SURGIXA

## SENN Retractors

Length 6¼" (16 cm) Blade 7 x 8.5 mm



Sharp	Blunt	Prongs
518-370	518-372	3

Non conductive insulated blade



Sharp	Blunt	Prongs
518-373	518-374	3

## DESMARRRES Lid Retractors

Length 5½" (14 cm), Full blades



Blades		Insulated Blades
10 mm	518-14410	518-14510
12 mm	518-14412	518-14512
14 mm	518-14414	518-14514
16 mm	518-14416	518-14516

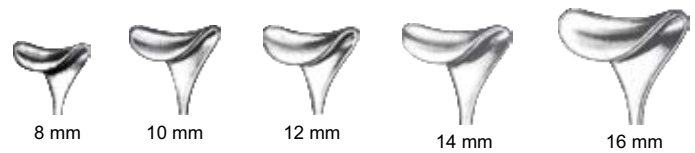

## COTTLE Alar Nasal Hook



	Blade size	Length
546-80015	12 x 13 mm	5½" (14 cm)

## JAEGER Lid Plate / Suturing Specula



Sharp	Insulated	Length
542-150	542-152	4¾" (11 cm)

## KASDEN Retractor

double ended



	Length
518-2070	6½" (16.5 cm)

## SHEEN PARKES Nasal retractor

Length 6¼" (16 cm)



	Blade
547-54516	10 mm

## SHEEN Retractor

Length 6" (15 cm)



	Blade
547-54615	6.5 mm



**O'CONNOR (IRIS) Hooks**

sharp

	Length
518-2001	5" (12.5 cm)
518-2002	6¼" (16 cm)



**CONVERSE Skin Hooks**

Length 7½" (19 cm)

	Size
518-2011	small
518-2012	large



**JOSEPH Skin Hooks**

Length 6¼" (16 cm)

Round Handle	Sharp
518-2021	1 prong
518-2022	2 mm, 2 prongs
518-2023	5 mm, 2 prongs
518-2024	7 mm, 2 prongs
518-2025	10 mm, 2 prongs

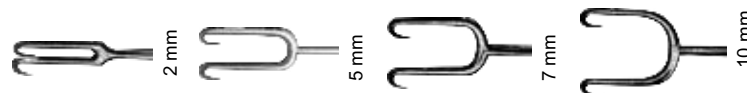

**KLEINERT KUTZ Hooklets**

Length 6¼" (16 cm)

	Tip
518-2033	3 mm
518-2035	5 mm
518-2037	7 mm



**McCOY Micro Dermal Hook**

	Length
518-2040	5" (13 cm)



**COTTLE Mucos Hook**

	Length
546-760	6¼" (16 cm)



**FRAZIER Dura & Skin Hooks**

Sharp	Blunt	Length
530-190	530-191	5¼" (13 cm)



**TYRELL Skin Hook**

Sharp	Length
518-2050	5" (13 cm)



**GRAEFE (IRIS) Hooklets**

Length 6¼" (16 cm)

Sharp	Blunt
518-240	518-242



# Retractors

Skin Hooks, Retractors

## GUTHRIE Hook Retractors

Length 5" (12.5 cm)

Sharp	Fig.	Tip
518-258		1.0 mm
518-260	1	1.5 mm
518-262	2	2.0 mm



## BARSKY Double Skin Hooks

	Length	Width
518-2045	6" (15 cm)	5 mm
518-2049	6¼" (16 cm)	9 mm



## KILNER Skin Hook

Very delicate, with round handle

	Length
540-050	6" (15 cm)



## GILLIES Skin Hooks, delicate

Length 7" (18 cm)

	Fig.
540-051	1
540-052	2



## COTTLE Nasal Hooks

Sharp / Sharp	Length
546-1020	6" (15 cm)



## ROLLET Rake Retractor

Length 5" (13 cm)

4 Sharp Prongs	4 Blunt Prongs
518-2064	518-2061



## MILLER Rake Retractor

Length 5¼" (13.5 cm), 9 prongs

Sharp	Blunt
518-2069	518-2068



## COTTLE-NEIVERT Double Hook Retractor

double ended, blunt hooks, with needle guide

	Length
546-1010	8¼" (21 cm)



## FOMON Nasal Retractors

double ball end prongs

	Length
546-1016	6¼" (16 cm)



Non conductive insulated blade

546-1017	single ball end prong
546-1018	double ball end prongs



**FARR Spring Retractors**

Length 5½" (14 cm)

	Opening
<b>518-80163</b>	6.3 cm

**ALM Skin Retractors**

self retaining

Sharp	Blunt	Length
<b>518-872</b>	<b>518-873</b>	4" (10 cm)

**HOLZHEIMER Skin Retractors**

4 x 4 Prongs, self retaining

Sharp	Blunt	Length
<b>518-890</b>	<b>518-891</b>	4" (10 cm)

**WEITLANER BABY Retractors**

2 x 3 Prongs, self retaining

Sharp	Blunt	Length
<b>518-930</b>	<b>518-931</b>	4¼" (11 cm)

**WEITLANER Retractors**

3 x 4 Prongs, self-retaining

Sharp	Blunt	Length
<b>518-940</b>	<b>518-941</b>	5" (12.5 cm)
<b>518-942</b>	<b>518-943</b>	6½" (16.5 cm)

**GELPI skin retractors**

Self-retaining

	Length
<b>519-18211</b>	4½" (11 cm)
<b>519-18216</b>	6¼" (16 cm)
<b>519-18218</b>	7" (18 cm)

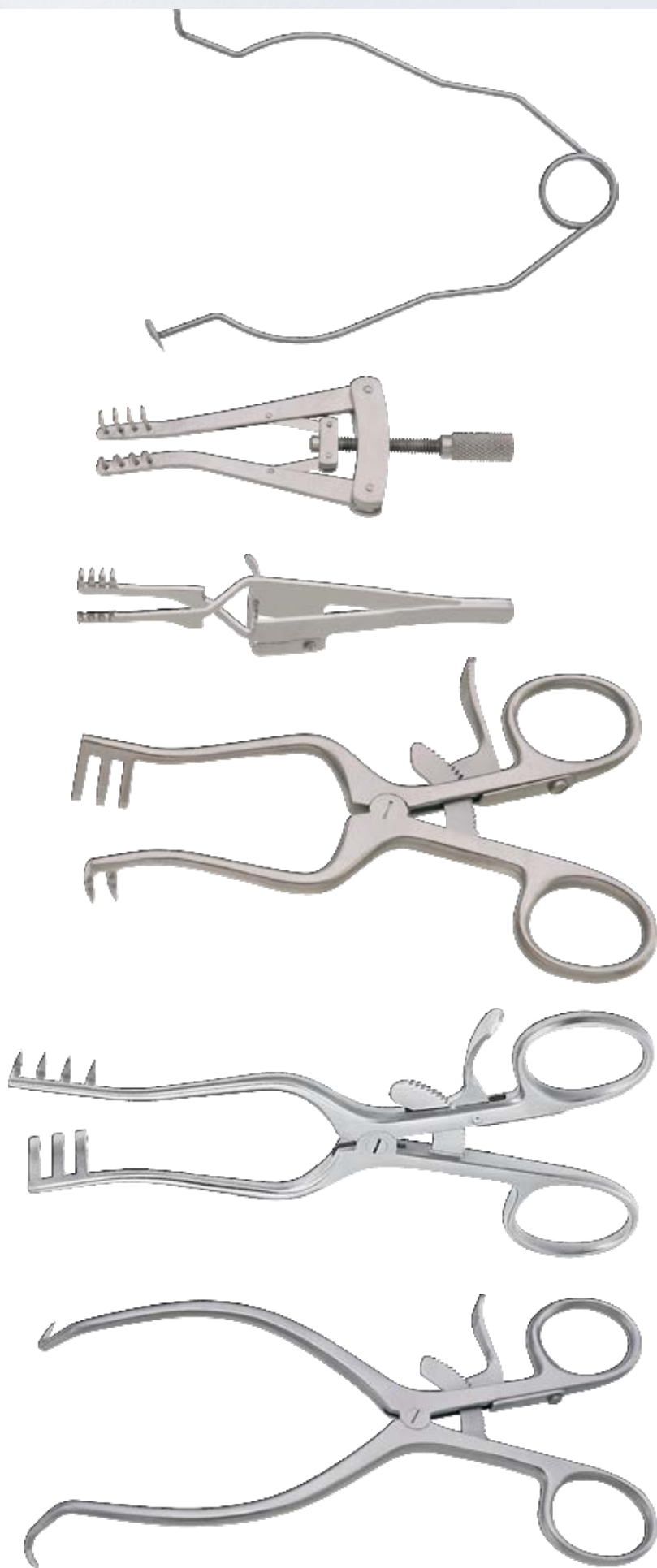

## Breast Dissectors

16 - 18



## Transumbilical Dissectors

18 - 19



## Endo Dissectors

21 - 24







Spatulated Dissector

	Length
572-1503	13" (33 cm)



JACOBS Breast Dissector

	Length
572-1513	13" (33 cm)



**AGRIS-DINGMAN Breast Dissectors**

Length 14¼" (36 cm), graduated

	Length	
572-1521	14¼" (36 cm)	Left
572-1522	14¼" (36 cm)	Right
572-1520	14¼" (36 cm)	Pair (set of 2), Left & Right
572-1523	16" (40 cm)	Extra long arms Pair (set of 2), Left & Right



**McCOLLUM-DINGMAN Submammary Dissector**

	Length
572-1530	12" (30 cm)



**McCOLLUM-DINGMAN Breast Dissectors**

	Length
572-1531	12½" (31.5 cm)
572-1541	16¼" (41.0 cm)

**EMORY Style Breast Dissector**  
curved, blunt blade

	Length
572-1593	12" (30 cm)





**REYNOLDS Transauxillary Breast Dissectors**

Full blade	Fenestrated	Length
572-1551	572-1553	13" (33 cm)
572-1552	572-1554	16" (40 cm)



**Breast Dissectors**  
angulated blades

Malleable	Rigid	Rigid	Length
572-1567	572-1563	572-1561	13" (33 cm)
572-1568	572-1564	572-1562	16" (40 cm)



**Breast Dissectors**  
spatulated blades

Malleable	Rigid	Rigid	Length
572-1577	572-1573	572-1571	13" (33 cm)
572-1578	572-1574	572-1572	16" (40 cm)



**Breast Dissectors**  
oval spatulated blades

Malleable	Rigid	Rigid	Length
572-1587	572-1583	572-1581	13" (33 cm)
572-1588	572-1584	572-1582	16" (40 cm)



**LOCKWOOD Underminer Dissector**  
Lift 40 mm

	Working length
572-1600	15¾" (400 mm)

**Trepsat Facial Flap Dissector Scissors**  
Length 7" (18 cm)

SuperCut	Size	Blades
572-1514	Small	9.5 mm x 14 mm
572-1518	Medium	12 mm x 18 mm
572-1540	Large	22 mm x 39 mm



**Breast / Facial Spreaders**  
blunt diamond shaped blade

	Width	Length / Size
572-17022	29 mm	8¾" (22.0 cm), small
572-17029	29 mm	11½" (29.5 cm), large



**Iconoclast (Breast Spreaders)**  
blunt straight blade

	Width	Length / Size
572-17122	3¼" (8.3 cm)	8¾" (22.0 cm), small
572-17129	5¾" (14.5 cm)	11½" (29.5 cm), large



**Transumbilical Breast Augmentation**  
Complete Set

- 572-2000 Complete set of 10
- 572-2001 V-Shaped breast dissector with handle
- 572-2002 Hockey stick breast dissector with handle
- 572-2003 Bullet & Round tip breast dissector with handle
- 572-2004 Bullet tips small
- 572-2005 Bullet tips large
- 572-2006 Round tips small
- 572-2007 Round tips large
- 572-2008 Handle only
- 572-2011 Trocar tube large
- 572-2012 Trocar tube small



**V-Shaped Breast Dissector**

Lightweight detachable resin handle



	Total length	Shaft length	Tip Width
<b>572-2001</b>	18 <sup>1</sup> / <sub>8</sub> " (46 cm)	12 <sup>1</sup> / <sub>2</sub> " (31.8 cm)	1/2" (13 mm)

**Hockey Stick Breast Dissector**

Lightweight detachable resin handle



	Total length	Shaft length	Tip Width
<b>572-2002</b>	18 <sup>1</sup> / <sub>8</sub> " (46 cm)	12 <sup>1</sup> / <sub>4</sub> " (31.1 cm)	1 <sup>1</sup> / <sub>8</sub> " (28 mm)

**Bullet and Round Tip Breast Dissector, without tip**

Includes 4 interchangeable tips & one lightweight detachable resin handle



	Total length	Shaft length	
<b>572-2003</b>	20" (50.8 cm)	12 <sup>1</sup> / <sub>4</sub> " (31.1 cm)	

**Trocar Breast Tubes**



	Size	Total length
<b>572-2011</b>	Large, (17.3 mm ID, 19 mm OD)	14" (35.6 cm)
<b>572-2012</b>	Small, (14 mm ID, 16 mm OD)	13 <sup>1</sup> / <sub>2</sub> " (34.3 cm)

**Accessories**

for Transumbilical Breast Augmentation Dissectors

Bullet tip	Size	For
<b>572-2004</b>	Large, (17.2 mm wide x 34.2 long)	<b>572-2003</b>
<b>572-2005</b>	Small, (13.9 mm wide x 33.0 long)	<b>572-2003</b>

Round tip	Size	For
<b>572-2006</b>	Large, (17.2 mm wide x 29.7 long)	<b>572-2003</b>
<b>572-2007</b>	Small, (13.9 mm wide x 30.7 long)	<b>572-2003</b>

Handle	For
<b>572-2008</b>	572-2001 - 572-2003



**Scalp Elevators**  
Length 9¾" (24 cm)



	Blade	Shape
<b>672-1601</b>	12.5 mm wide	slightly curved



	Blade	Shape
<b>672-1602</b>	12.5 mm wide	slightly curved



	Blade	Shape
<b>672-1604</b>	12.5 mm wide	"S" Shaped



	Blade	Shape
<b>672-1605</b>	15 mm wide	slightly curved



	Blade	Shape
<b>672-1603</b>	7 mm wide	straight



	Blade	Shape
<b>672-1606</b>	7 mm wide	quarter curved



	Blade	Shape
<b>672-1607</b>	7 mm wide	fully curved



	Blade	Shape
<b>672-1608</b>	7 mm wide	half curved



## Scalp Elevators

Length 9¾" (24 cm), with Suction



	Blade	Shape
672-1611	7 mm wide	slightly curved

Length 10½" (26 cm), with Suction



	Blade	Shape
672-1612	8.5 mm wide	slightly curved

## Frontotemporal Dissectors

	Length / Tip	Shape
672-1621	9" (22.5 cm) / 5 mm	slightly curved



	Length / Tip	Shape
672-1622	9" (23 cm) / 7 mm	slightly curved



	Length / Tip	Shape
672-1623	9" (23 cm) / 10 mm	slightly curved



## Frontoglabbellar Dissectors

Length 10½" (26.5 cm)

	Tip	Shape
672-1641	7 mm	"S"-Shaped



## Flap Dissector

Length 9½" (23.5 cm)

	Tip	Shape
672-1643	5 mm	straight



**Flap Dissector**

Length 9½" (23.5 cm)

	Tip	Shape
<b>672-1644</b>	7 mm	straight



**Zygomatic Arch Elevator**

Length 8¼" (20.5 cm)

	Blade	Shape
<b>672-1651</b>	5 mm	straight



**Orbital Rim Dissector**

Length 9" (22.5 cm)

	Tip	Shape
<b>672-1653</b>		slightly curved



**Temporal T- Dissector**

Length 9½" (23.5 cm)

	Tip	Shape
<b>672-1629</b>	10 mm	straight



**Periosteal Elevators**

Length 10" (25 cm)

	Tip	Shape
<b>672-1631</b>	12 mm	"S"-Shaped



**Periosteal Spreaders**

Length 9¾" (24 cm)

	Blade Width	Shape
<b>672-1632</b>	8 mm	"S"-Shaped



Length 9¾" (24 cm)

	Blade Width	Shape
<b>672-1633</b>	10 mm	"S"-Shaped



## Arcus Marginalis Dissectors

Length 9¾" (24 cm)



	Tip	Shape
672-1642	10 mm	"S"-Shaped

## Midface Facial Dissectors

Length 9¾" (24 cm)



	Tip	Shape
672-1652	12 mm wide	Multiple curves

## Transoral Dissectors

Length 9¾" (23.5 cm)



	Shape
672-1654	Curved

## Corrugated & Procerus Muscle Dissector

Length 9" (23 cm)



	Blade	Shape
672-1660	5 mm	Curved

## Corrugated & Procerus Muscle Dissector

Length 7¾" (19.5 cm)



	Blade
672-1661	4.7 mm

## Nerve Protectors

Length 6¾" (17 cm)



	Blade	Shape
672-1662	4.5 mm	Curved Left

**Nerve Protectors**

Length 6¾" (17 cm)

	Blade	Shape
672-1663	4.5 mm	Curved Right



**Nerve Cutting Knife**

Length 6¾" (17 cm)

	Blade	Shape
672-1664	3 mm	Curved



**Knife handle, for plastic surgery**

	Length
672-1669	8¼" (20.5 cm)



**Nerve Hooks**

Length 9¾" (24 cm)

	Shaft
672-1667	Rigid
672-1668	Malleable



**Nerve Dissector**

Length 9¾" (24 cm)

	Blade	Style
672-1670	4.7 mm	"Cobra"



**Nerve Hooks**

Length 9¾" (24 cm)

Left Hook	Right Hook
672-1665	Left
672-1666	Right



## Markers & Caliper

26 - 28



## Calipers

28 - 30





**FREEMAN Areola Markers**

Stainless steel, light weight pattern, semi-sharp

| Size (1 in 1)

572-17934	34 mm
572-17936	36 mm
572-17938	38 mm
572-17942	42 mm
572-17945	45 mm
572-17950	50 mm



**GROSSMAN Areola Marker**

| Blades

572-1800	4 sizes in 1 40 / 44 / 48 / 52 mm
----------	--------------------------------------



**FREEMAN Areola Markers**

with inner markings, made from light weight aluminium

| Size (2 in 1)

572-18134	34 / 36 mm
572-18138	38 / 42 mm
572-18145	45 / 50 mm



**FREEMAN Areola Markers**

Stainless steel

| Size (1 in 1)

572-18215	15 mm
572-18218	18 mm
572-18220	20 mm
572-18222	22 mm
572-18225	25 mm
572-18228	28 mm
572-18230	30 mm
572-18232	32 mm
572-18234	34 mm
572-18236	36 mm
572-18238	38 mm
572-18242	42 mm
572-18245	45 mm
572-18250	50 mm
572-18252	52 mm



**FREEMAN Areola Markers**

Stainless steel, double sided

| Size (2 in 1)

572-18034	34 / 36 mm
572-18038	38 / 42 mm
572-18042	42 / 45 mm
572-18045	45 / 50 mm



## ACKERMANN Areola Markers

Length 4" (10 cm)

	Size
572-18314	5½" (14 cm), small
572-18316	6¼" (16 cm), large

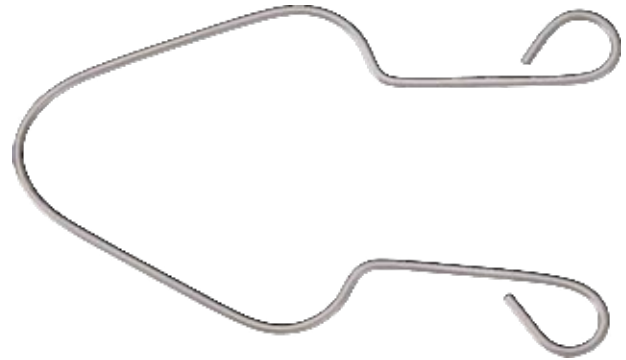

## McKISSOCK Keyhole Markers/Calipers

Length 5½" (14 cm)

	Size
572-18438	38 mm
572-18442	42 mm
572-18445	45 mm
572-18450	50 mm

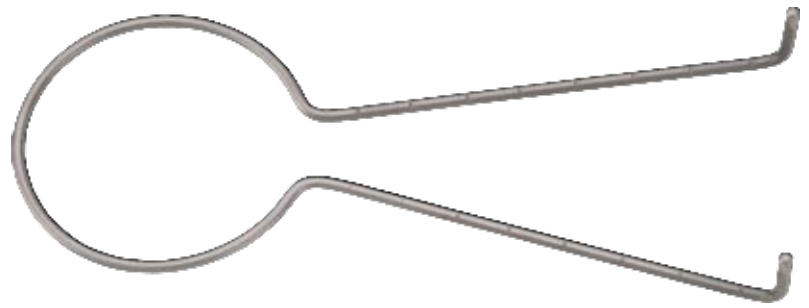

## WALDEN Breast Marker

	Length
572-18514	9" (14 cm)

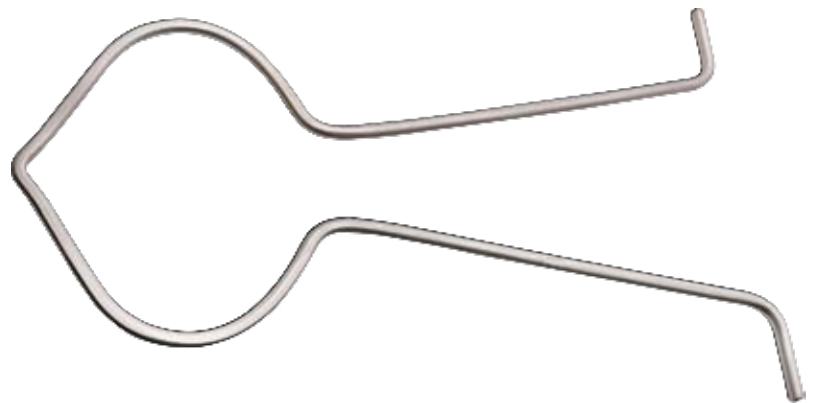

## Projectometer

Depth adjustable from 5-50 mm

	Length
572-2010	6" (15 cm)

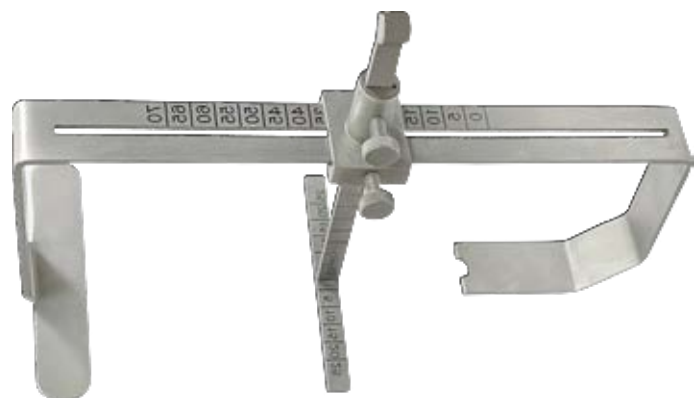

## PITANGUY Flap Grasping Forceps

	Length
572-1850	5½" (14 cm)

## D'ASSUMPCAO Face-Lift Markers

Length 6¼" (16 cm)

	Ratchet
572-1860	without ratchet
572-1862	with ratchet

## PITANGUY Facial Demarcators

	Length
572-1870	6¼" (16 cm)
572-1871	10" (25.5 cm)

## MARTEN Flap Markers

Length 5¾" (14.5 cm)

	Ratchet
572-1880	without ratchet
572-1882	with ratchet



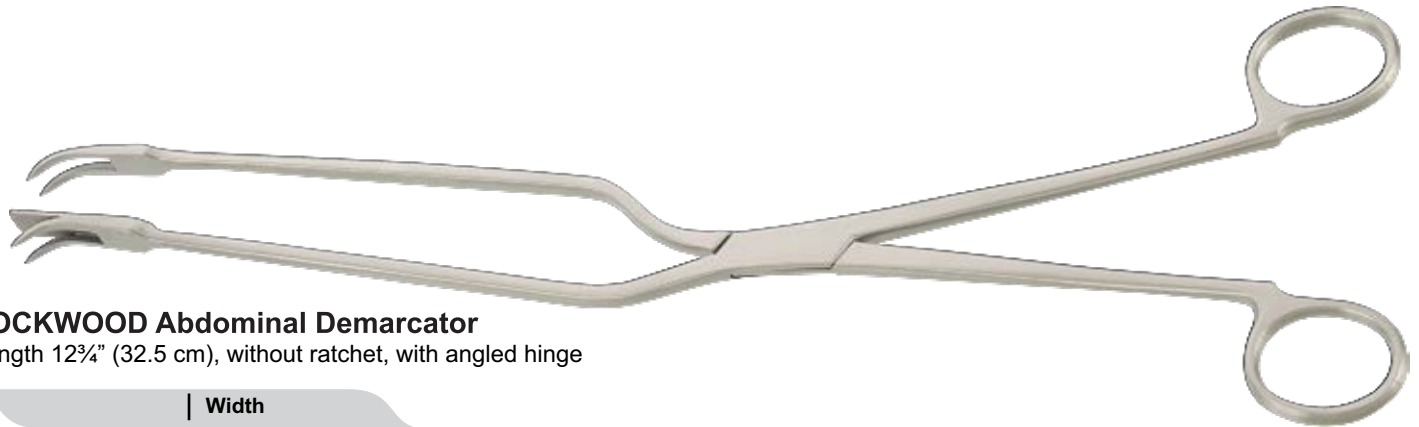

## LOCKWOOD Abdominal Demarcator

Length 12¾" (32.5 cm), without ratchet, with angled hinge

	Width
572-1866	9.5 mm



## Metal Rulers

with inch and cm graduations

	Measuring range
502-18015	6" (15 cm)
502-18020	8" (20 cm)

## McKISSOCK (COLLYER) Caliper

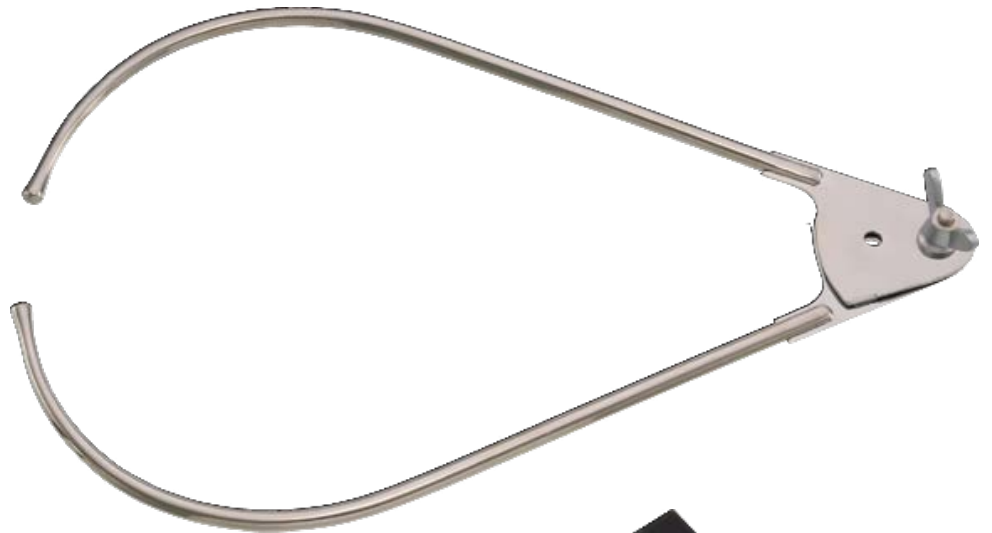

	Size
572-1910	12" (30 cm)

## SHEEN Grid - With mm Graduation

Made from stainless steel

	Graduation
572-1927	70 x 40 mm (Black)
572-1928	70 x 40 mm (Blue)



**GRUBER Cartilage Cutting Block**

	Size
<b>572-1930</b>	4" x 4" x 1/8"
<b>572-19301</b>	9" x 6" x 1/4"
<b>572-19302</b>	7½" x 4" x 1" & 50 durometers

**HALPREN Breast Calipers**

	Size
<b>572-1934</b>	34 mm
<b>572-1938</b>	38 mm
<b>572-1942</b>	42 mm

**JAMESON Calipers**  
Scale 0 - 80 mm

	Size
<b>502-31710</b>	3¾" (9.5 cm)

**THORPE (MARCHAC) Calipers**  
Scale 0 - 80 mm

	Size
<b>502-31912</b>	4¾" (12 cm)

**CASTROVIEJO Calipers**  
Scale 0 - 20 mm

	Size
<b>502-58320</b>	3½" (9 cm)





**Curettes & Extractors**

32



**Elevators**

33 - 34



**Osteotomes, Chisels, Gouges**

34 - 36



**Mallets**

37 - 38



**FOX Dermal Curettes**

Length 5½" (14 cm)



Fig./Spoon	Oval	Round
00 (1 mm)	<b>540-019</b>	<b>540-025</b>
0 (2 mm)	<b>540-020</b>	<b>540-026</b>
1 (3 mm)	<b>540-021</b>	<b>540-027</b>
2 (4 mm)	<b>540-022</b>	<b>540-028</b>
3 (5 mm)	<b>540-023</b>	<b>540-029</b>
4 (6 mm)	<b>540-024</b>	<b>540-030</b>

**SCHAMBERG Comedon Extractors**

Working Length 4" (10 cm)



medium, with crimp	<b>540-080</b>
extra fine, with crimp	<b>540-081</b>
delicate, with crimp	<b>540-082</b>
heavy, with crimp	<b>540-084</b>
delicate, without crimp	<b>540-083</b>

**UNNA Comedon Extractors**

double ended oval, with hole



	Working Length
<b>540-060</b>	5¾" (14.5 cm)

**UNNA Comedon Extractors**

double ended oval, with hole



	Working Length
<b>540-061</b>	4¾" (12 cm)
<b>540-062</b>	5½" (14 cm)

**CONVERSE Curettes**

Double ended, 6.5 x 8.5 mm / 7 x 10 mm



	Working Length
<b>544-76321</b>	8½" (21 cm)

**WILLIGER Bone Spoon**

Length 5¼" (13.5 cm), Oval, sharp, double ended



Fig.	
00/0	<b>528-520</b>
0/1	<b>528-522</b>
1/2	<b>528-524</b>

**MARTINI Bone Spoon**

Length 5¼" (13.5 cm), round, sharp, double ended



Fig.	
00/0	<b>528-530</b>
0/1	<b>528-532</b>
1/2	<b>528-534</b>

Elevators

**ROWE Zygomatic Bone Elevators**



Length
10" (25.5 cm) 549-55025

**GORNEY Suction Elevators**

Tip 4 mm, with stylet



Length	Regular	Black Ebonized
7½" (19 cm)	547-40119	

**FREER Elevators**

double ended



Width	Length		
	7" (18 cm)	sharp/blunt	546-594
5 mm	7½" (19.5 cm)	blunt/blunt	546-595
6.5 mm	7½" (19.5 cm)	sharp/blunt	546-596

**COTTLE Septum Elevator**

double ended, graduated



Length
9" (23 cm) 546-53022

**WOODSON Elevator**

Length 7" (18 cm), double ended



4 x 10 mm, flat edge end	547-50318
2 x 11 mm, semi sharp tip	

**McCOLLOUGH Elevator**

double ended



Length
547-50418 7¼" (18.5 cm)

**MITCHELLS Trimmer/Elevator**

knife blade & spoon shaped elevator



Length
547-43317 6¾" (17 cm)

**WILLIGER Elevator**

Length 6¼" (16 cm)



Tip
4 mm 528-54616

**McKENTY Elevators**

Length 6" (15 cm), sharp



Tip	Curved
4 mm	<b>546-42004</b>
5 mm	<b>546-42005</b>

**JOSEPH Periosteal Elevator**

Length 6¼" (16 cm)



Tip	
4 mm	<b>546-53416</b>

**COTTLE Periosteal Elevator**



Length	
7½" (19 cm)	<b>546-54019</b>

**OBWEGESSER Periosteal Elevators**

Length 7" (17.5 cm)



Tip	
6 mm	<b>549-56406</b>
7 mm	<b>549-56407</b>
9 mm	<b>549-56409</b>
11 mm	<b>549-56411</b>

**BOIES Elevator**



Length	
7¾" (19.5 cm)	<b>547-57719</b>

**BALLENGER Swivel Knives**

Length 7¾" (20 cm)



Straight	Bayonet	Blade Width
<b>546-40003</b>	<b>546-40103</b>	3 mm
<b>546-40004</b>	<b>546-40104</b>	4 mm
<b>546-40005</b>	<b>546-40105</b>	5 mm
<b>546-40006</b>	<b>546-40106</b>	6 mm

**SILVER Rhinoplastic Chisels**

Length 7" (18 cm)



Straight	<b>546-6141</b>
Right	<b>546-6142</b>
Left	<b>546-6143</b>

## GUNTER Rhinoplastic Chisels

Length 8¼" (21 cm)



Straight	547-4631
Right	547-4632
Left	547-4633

## NEIVERT Rhinoplastic Chisels

Length 8½" (21.5 cm)



Straight	547-4691
Right	547-4692
Left	547-4693

## RISTOW Rhinoplastic Chisels

Length 8" (20.5 cm)



Right	547-4771
Left	547-4772

## PARKES Lateral Osteotome

Length 7" (18 cm), 4mm tip, with guard



Straight	547-47518
----------	-----------

## REES Osteotome

Length 8" (20.5 cm)



3 mm	547-4483
------	----------

## FREER Chisels

Length 6¼" (16 cm)



Straight	546-58016
Curved	546-58216

## PARKES Gouge

Length 7" (18 cm)



6.5 mm	547-47918
--------	-----------

## CONVERSE Osteotomes

Length 7" (18 cm)



Tip		Tip	
2 mm	547-47102	7 mm	547-47107
3 mm	547-47103	8 mm	547-47108
4 mm	547-47104	9 mm	547-47109
5 mm	547-47105	10 mm	547-47110
6 mm	547-47106	11 mm	547-47111



**SHEEN Radix Chisels**

Length 7" (18 cm), 10 mm wide tip



Angle	Part Number
10°	547-44710
20°	547-44720

**SHEEHAN Osteotomes**

Length 6¼" (16 cm)



Tip	Part Number	Tip	Part Number
2 mm	546-64002	8 mm	547-64008
3 mm	546-64003	9 mm	547-64009
4 mm	547-64004	10 mm	547-64010
5 mm	547-64005	11 mm	547-64011
6 mm	547-64006	12 mm	547-64012
7 mm	547-64007	15 mm	547-64015

**RUBIN Type Osteotomes**

Length 7" (18 cm)



Tip	Part Number
6 mm	546-64406
8 mm	546-64408
10 mm	546-64410
11 mm	546-64411
12 mm	546-64412
14 mm	546-64414
16 mm	546-64416

**CINELLI Chisels**

Length 6¼" (16 cm), double guarded



Tip	Part Number
10 mm	546-63410
12 mm	546-63412
14 mm	546-63414
16 mm	546-63416

**COTTLE Osteotomes**

Length 7" (18 cm), graduated



Tip	Part Number	Tip	Part Number
2 mm	546-62202	8 mm	546-62208
4 mm	546-62204	9 mm	546-62209
6 mm	546-62206	10 mm	546-62210
7 mm	546-62207	12 mm	546-62212

**LAMBOTTE Osteotomes**

Length 6¾" (17 cm)



Tip	Straight	Curved
2 mm	528-09202	528-09302
3 mm	528-09203	528-09303
4 mm	528-09204	528-09304
6 mm	528-09206	528-09306

**GERZOG Mallet**

Head 225 g (8 oz.), Ø 1" (25 mm)



| Length |

7" (18 cm)

**528-18018**

**MEAD Mallet**

Head dia. 26 mm, 320 g (11 1/4 oz.), with plastic facings



| Length |

**528-320**

6 3/4" (17 cm)

**528-32099**

Spare nylon head

**Mallet**

Head dia. Ø 1" (25 mm), 250 g (8 7/8 oz.), with plastic fiber handle

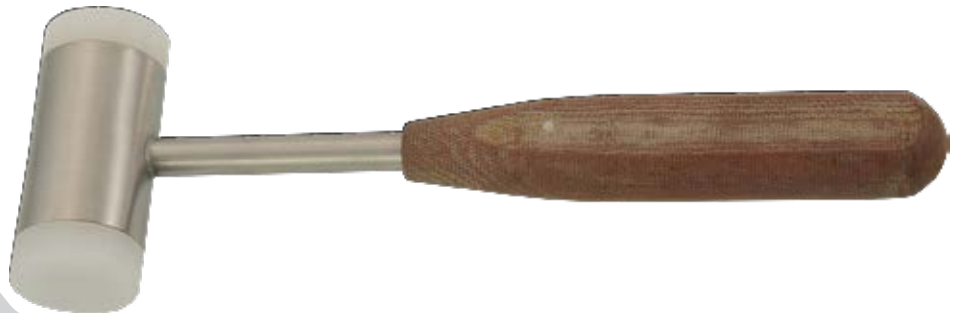

| Length |

7" (18 cm)

**528-16218**

**Mallet (Nylon / Steel)**

Head dia. Ø 1" (25 mm), 265 g (9 3/8 oz.), with one face steel and one face Nylon



| Length |

**528-16318**

7 1/4" (18.5 cm)

**Bone Mallet**

Head dia. Ø 3/4" (19 mm), 140 g (5 oz.)

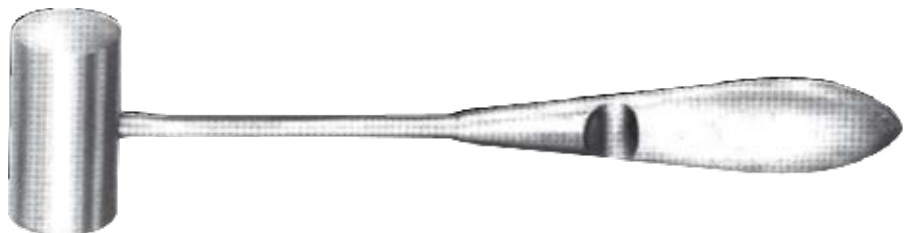

| Length |

6 1/2" (16.5 cm)

**528-14016**

**Mallet (Nylon)**

Head dia. Ø 1" (25 mm), 255 g (9 oz.), with nylon heads

	Length
<b>528-16418</b>	7¼" (18.5 cm)
<b>528-16499</b>	Spare nylon head

Head dia. Ø ¾" (19 mm), 218 g (7 5/8 oz.), delicate, with nylon heads

	Length
<b>528-16518</b>	7" (18 cm)
<b>528-16599</b>	Spare nylon head



**COTTLE (LUCAE) Mallet**

Head dia. Ø 30 mm, 240 g, with 1 side flat and 1 side convex

Length		Head Diameter	Head Weight
7" (18 cm)	<b>528-14425</b>	Ø 1" (25 mm)	265 g (9 3/8 oz.)
8" (20 cm)	<b>528-14430</b>	Ø 1-3/16" (30 mm)	200 g (7 3/4 oz.)

**LUCAE Bone Mallet**

Length 7½" (19 cm), Head dia. Ø ¾" (19 mm)

	230 g (8 oz.)	<b>528-15019</b>
	260 g (9 oz.)	<b>528-15025</b>



**Nasal Speculas**

40



**Mouthgag**

40



**Nasal Dressing & Cutting Forceps**

41, 43



**Septum Forceps**

41



**Septum Shears**

42



**Morselizers & Crushers**

42 - 43

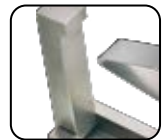

**Nasal Rasps**

44 - 45



**Bone Files & Otopraders**

46



**KILLIAN Nasal Speculas**

Length 5" (13 cm)



Fig.	Working Length		With Light Guide	With Fixation Scerw
1	35 mm	<b>546-031</b>	<b>572-1180</b>	<b>546-0351</b>
2	50 mm	<b>546-032</b>	<b>572-1182</b>	<b>546-0352</b>
3	75 mm	<b>546-033</b>	<b>572-1184</b>	<b>546-0353</b>
4	90 mm	<b>546-034</b>	<b>572-1186</b>	<b>546-0354</b>

**COTTLE Nasal Speculas**

Length 5" (13 cm)



	Working Length		With Fixation Scerw
	35 mm	<b>546-07035</b>	<b>546-07135</b>
	50 mm	<b>546-07050</b>	<b>546-07150</b>
	75 mm	<b>546-07075</b>	<b>546-07175</b>
	90 mm	<b>546-07090</b>	<b>546-07190</b>

**VIENNA Nasal Speculas**

Length 5½" (14 cm)



	Size	
	infant	<b>546-041</b>
	child	<b>546-042</b>
	adult	<b>546-043</b>

**DINGMANN Mouthgag**

	Size
<b>548-130</b>	Complete Set
<b>548-131</b>	Blade Fig. 1 only
<b>548-132</b>	Blade Fig. 2 only
<b>548-133</b>	Blade Fig. 3 only
<b>548-134</b>	Frame only





**SHEEN-KILLIAN Septum/Nasal Forceps**

shaft 3<sup>3</sup>/<sub>4</sub>" (82mm), flat serrated jaw 25 x 5.5 mm

Length	
6 <sup>3</sup> / <sub>4</sub> " (17 cm)	<b>546-250</b>



**WEIL-BLAKESLEY (WILDE) Nasal Cutting Forceps**

Shaft length 4<sup>3</sup>/<sub>4</sub>" (12 cm)

Tip	Straight	
2.5 mm	<b>646-35125</b>	
3.0 mm	<b>646-35130</b>	
3.6 mm	<b>646-35136</b>	
4.2 mm	<b>646-35142</b>	
4.8 mm	<b>646-35148</b>	

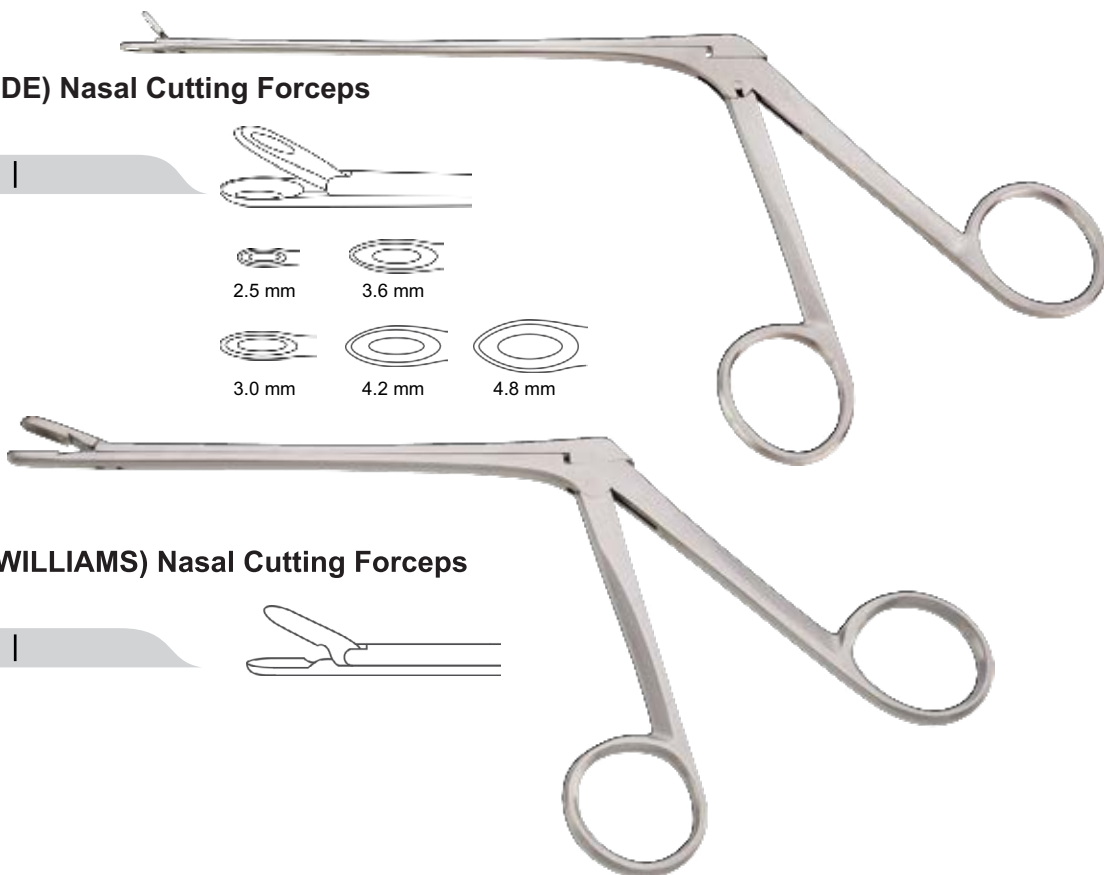
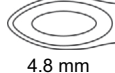
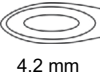
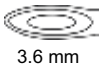
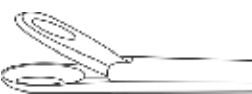

**TAKAHASHI (WATSON-WILLIAMS) Nasal Cutting Forceps**

Working length 4<sup>3</sup>/<sub>4</sub>" (12 cm)

Tip	Straight	
3 x 10 mm	<b>646-331</b>	

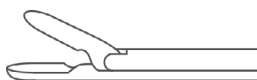

**ASCH Septum Straightening Forceps**

angled on flat

Length	
9" (23 cm)	<b>546-83423</b>

**WALSHAM Septum Straightening Forceps**

Length 9" (23 cm)

Straight		<b>546-84023</b>
Left		<b>546-84223</b>
Right		<b>546-84423</b>



**GORNEY Scissors**

Angled, Double Action

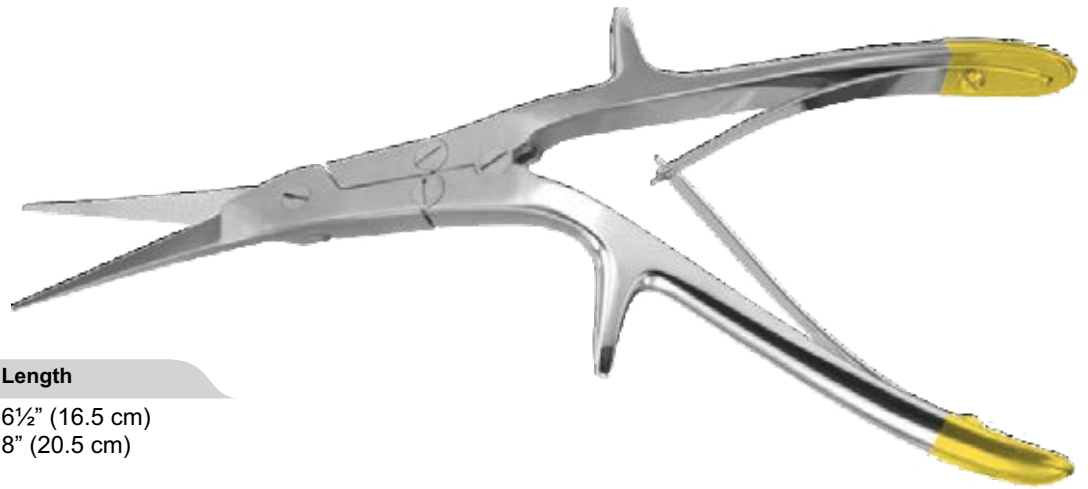

Standard	TC	Length
510-46021	509-43016	6½" (16.5 cm)
	509-46021	8" (20.5 cm)

**CAPLAN Scissors**

Angled, Double Action

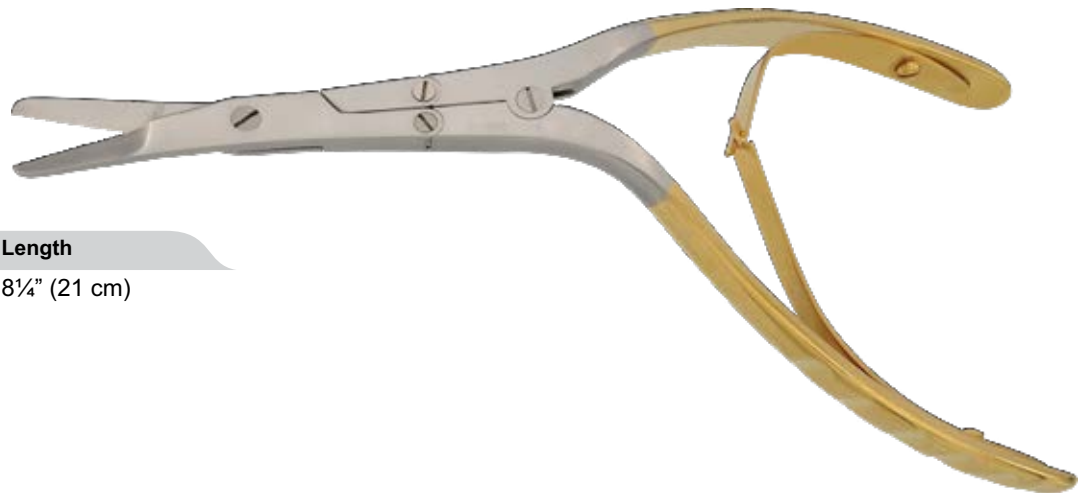

Standard	TC	Length
510-46221	509-46221	8¼" (21 cm)

**GUNTER Morselizers**

TC

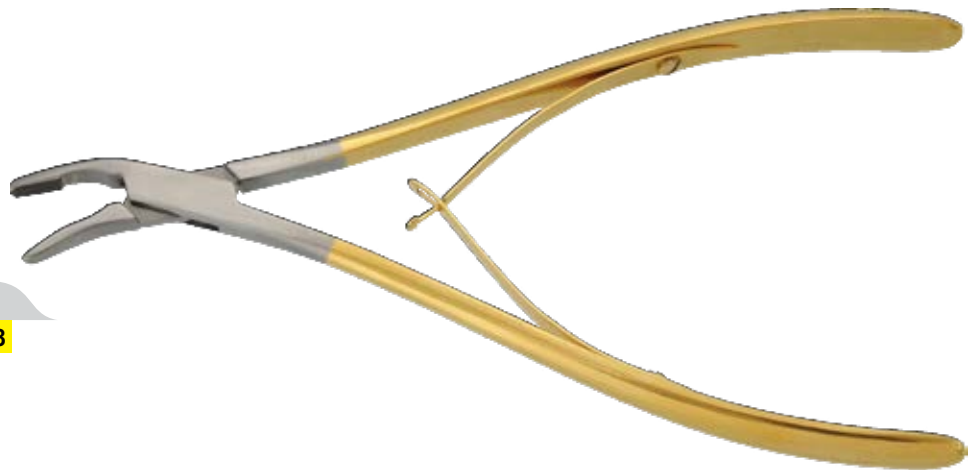

Length	Serrated
7" (18 cm)	547-25318

**GORNEY Septal Morselizers**

One jaw TC with large pyramid-shaped teeth other jaw TC with longitudinal ridges



Morselizer jaw

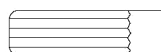

Longitudinal jaw one side

Length	
7¼" (18.5 cm)	547-25520

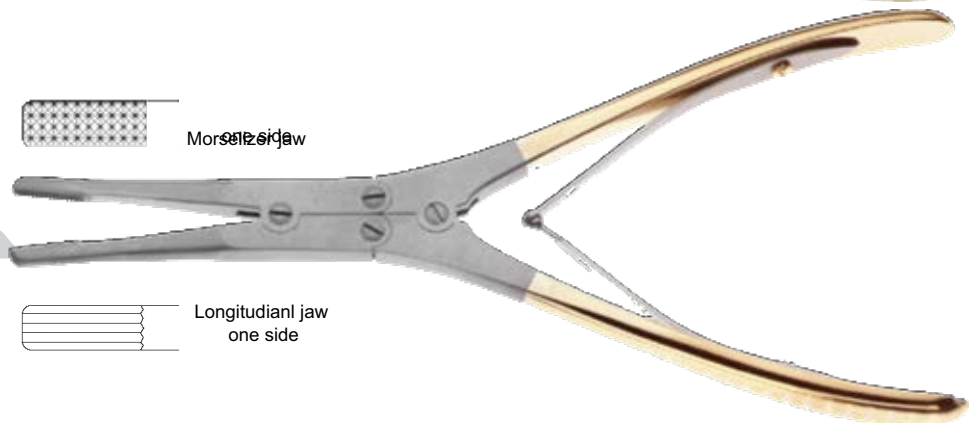

**RUBIN Septal Morselizers**  
Serrated angled shanks, with gaurd

Length	TC
8¼" (21 cm) 547-33921	547-34021



**JANSEN-MIDDLETON Nasal Cutting Forceps**

Length
546-440 7¾" (19.5 cm)



**GUBISCH (JOST) Crusher Morselizer**

65 x 30 mm 547-53820
----------------------



**COTTLE Cartilage Crusher**  
With clip

smooth bed 547-53800
serrated bed 547-53801



**TOLSDORF Cartilage Crusher**  
Round

serrated bed 547-53810
smooth bed 547-53811





**FOMON Nasal Rasps**

Length 8" (20 cm), TC double sided

Fig.	Teeth	TC
1/2	12/14	547-5221
3/4	16/20	547-5223
5/6	24/30	547-5225
7/8	36/44	547-5227
9/10	52/62	547-5229

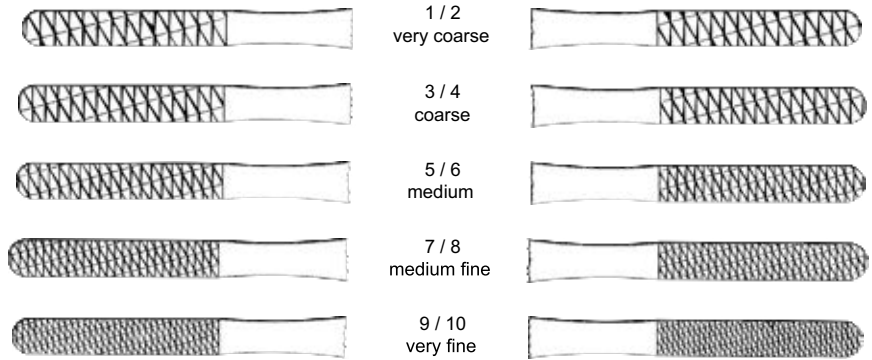

**PARKES Nasal Rasps**

Length 8 1/4" (21 cm), TC

Fig.	Teeth	TC Regular	
1	12	546-5061	very coarse
2	14	546-5062	very coarse
3	16	546-5063	coarse
4	20	546-5064	coarse
5	24	546-5065	medium
6	30	546-5066	medium
7	36	546-5067	fine medium
8	44	546-5068	fine
9	52	546-5060	very fine
10	62	546-5070	very fine



**LEWIS Nasal Rasps**

Length 7" (18 cm)

	Standard	TC
Fine teeth	546-710	546-711
Coarse teeth	546-712	546-713

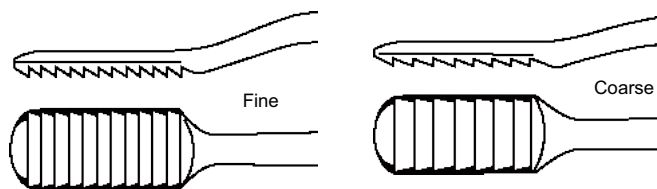

**GLABELLA Nasal Rasps**

TC	Length
547-5050	8 1/4" (21 cm)

**MALTZ Nasal Rasps**

Length 7" (18 cm), flat handle

Cutting	TC	
down/pull	546-750	546-752
up/push	546-751	546-753

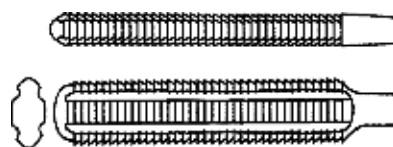





**FOMON Nasal Rasps**

4 sided

Length
546-69621 8¼" (21 cm)



**COTTLE (PARKES) Nasal Rasps**

Downwards cutting

Length
546-700 8¼" (21 cm)

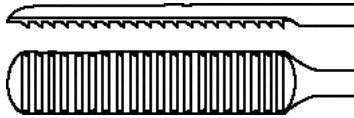

**AUFRICHT Nasal Rasps**

Length 8½" (21.5 cm)

Standard	Cutting
546-730	Upwards
546-732	Downwards

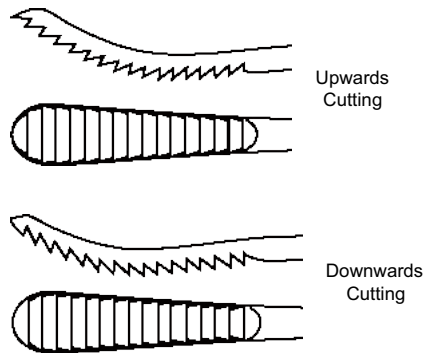

**JOSEPH Nasal Rasps**

medium teeth

Length
546-67016 6¼" (16 cm)

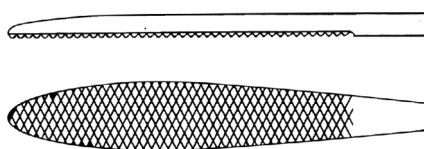





**MILLER-COLBOURNE Bone Files**

TC double sided Length 7" (18 cm), double sided

Fig.	Downwards	Cross Cutting
1	582-86101	582-86201

**DINGMAN Otopraders**

Length 6" (15 cm)

547-20101	Right
547-20102	Left
547-20195	Set (left + right)

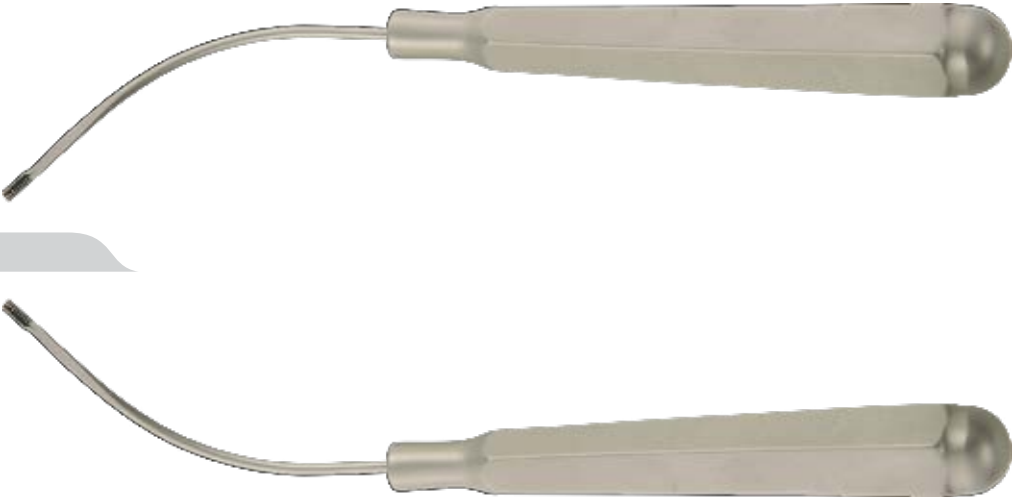

## Bone Rongeurs

48 - 49

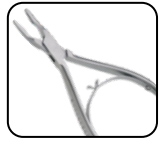

## Bone Cutting Forceps

49



## Wire Twister

50



## Wire Cutters

51



## Wire Pliers

52



**BEYER Bone Rongeurs**  
3 mm Jaw

Length	Curved
7" (18 cm)	528-1201



**LEMPERT Bone Rongeurs**

Length	Straight	Curved
8" (20 cm)	528-1110	528-1111



**FRIEDMAN Bone Rongeurs**

Length	Curved
5½" (14 cm)	528-1101



**MINI-FRIEDMAN Bone Rongeurs**

Length	Curved
4¾" (12 cm)	528-1091



## CLEVELAND Bone Rongeurs

Length	Curved
5½" (14 cm)	528-1171



## LISTON Bone Cutting Forceps

Length	Straight	Curved
5½" (14 cm)	528-1280	528-1281
6¾" (17 cm)	528-1282	528-1283



## RUSKIN-LISTON Bone Cutting Forceps

Double action

Length	Straight	Curved
6" (15 cm)	528-1306	528-1307
7¼" (18.5 cm)	528-1310	528-1311

## KLEINERT-KUTZ Bone Cutting Forceps

Length	Straight	Curved
5½" (14 cm)	532-128214	532-128314

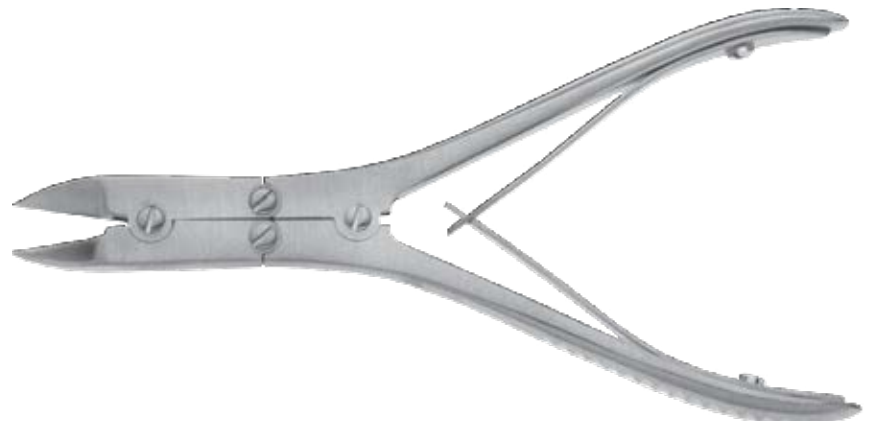

**CARROLL Tendon Seizing Forceps**

	Working Length
532-95911	4¼" (11 cm)

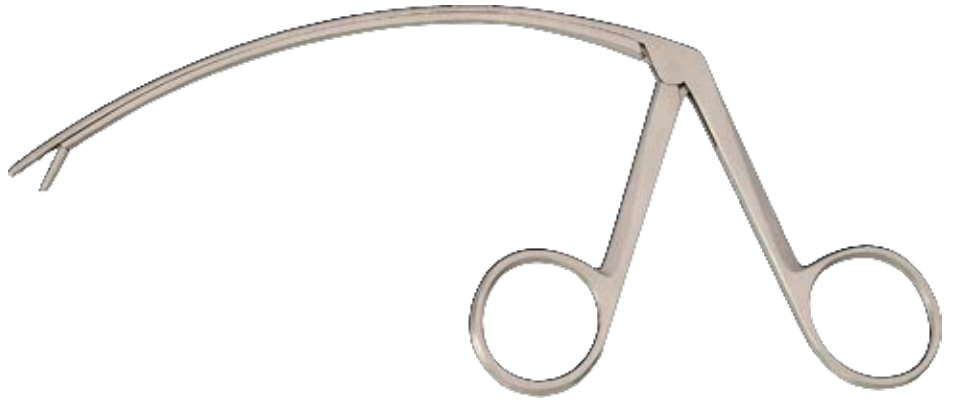

**CORWIN Automatic Wire Twisters**

Length	Fig.	TC
6" (15 cm)	1	533-5281
6" (15 cm)	2	533-5282
6¼" (16 cm)	3	533-5283
7" (18 cm)	4	533-5284

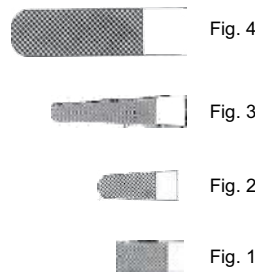
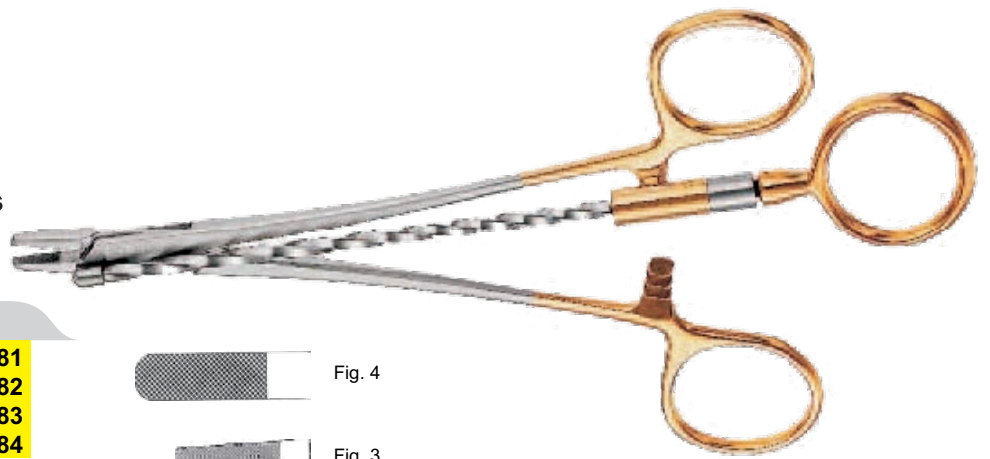

**Wire Twisters**  
Length 6¼" (16 cm)

Fig.	TC
long jaw	533-53016
flat jaw	533-53216
round jaw	533-53416

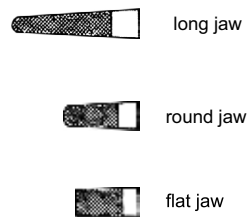
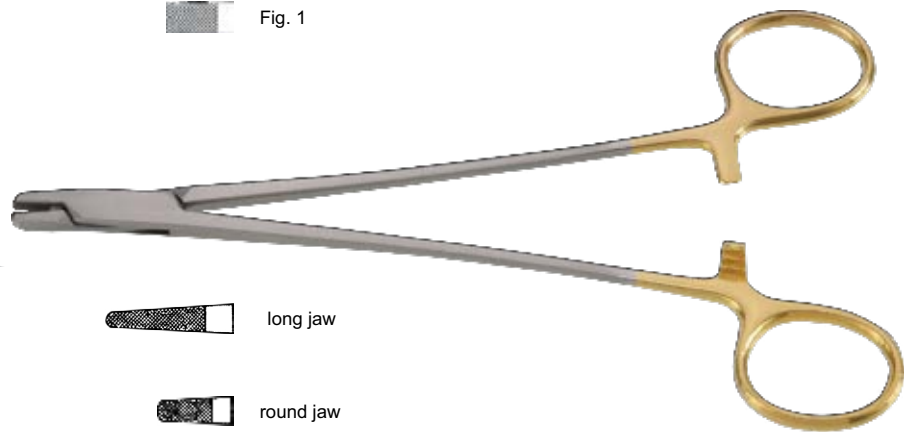



### Wire & Pin Side Cutter

for hard wire upto 1.7 mm dia.

Length

TC

7" (18 cm)

533-54518



### Wire & Pin Side Cutter

for hard wire upto 2.5 mm dia.

Length

TC

8 3/4" (22 cm)

533-54522



### Wire & Pin Face and Side Cutter

for hard wire upto 1.7 mm dia.

Length

TC

7" (18 cm)

533-54618



### Wire Seizing Forceps

Length 7" (18 cm), parallel grip, double action

Standard	TC	Tip
526-2541	526-2551	2.5 mm
526-2542	526-2552	5 mm

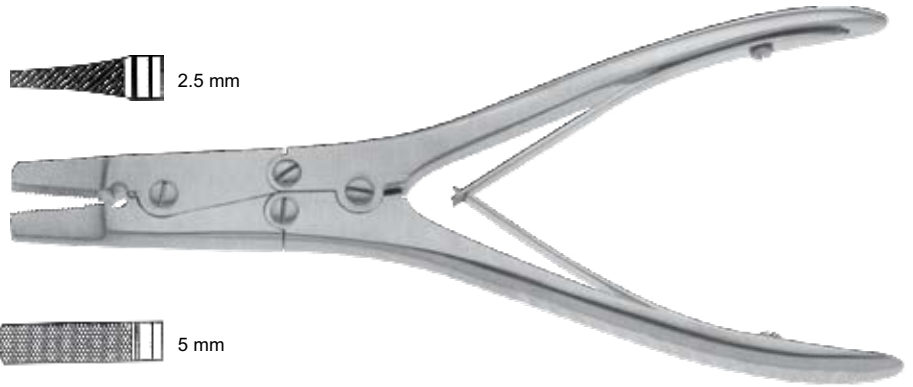

### Wire Flat Pliers

face cutting, for 2.0 mm wire

Length	
6 <sup>3</sup> / <sub>4</sub> " (17 cm)	526-2501
6 <sup>3</sup> / <sub>4</sub> " (17 cm)	526-2502

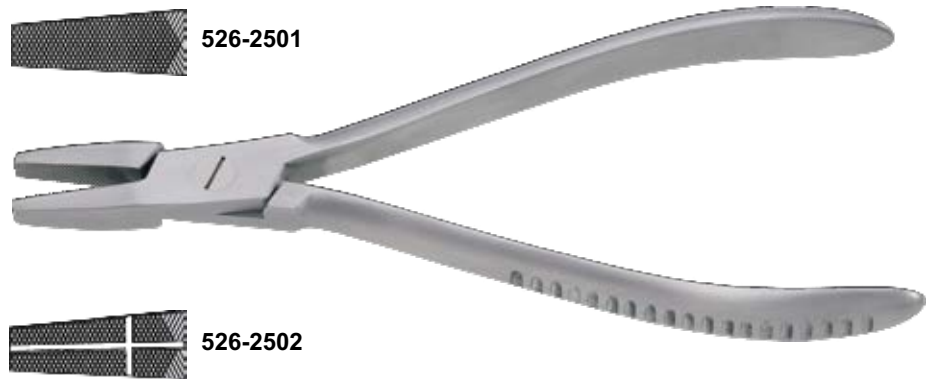

### Universal Flat Nose Pliers

Length	
8" (20 cm)	533-53820

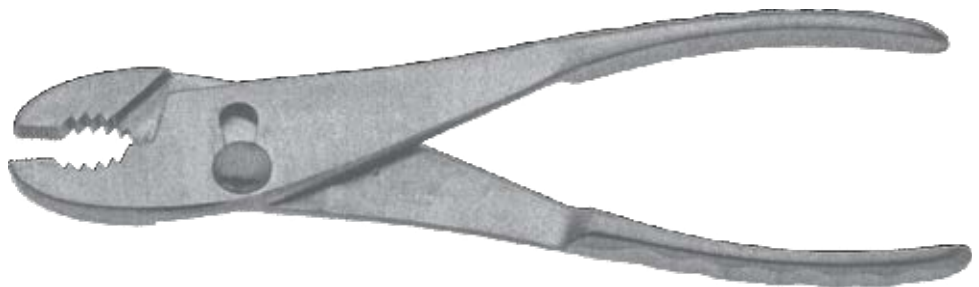

### Needle Nose Pliers

cross serrated

Length	
5 <sup>1</sup> / <sub>2</sub> " (14 cm)	533-56814



## Operating & Dissecting Scissors

54 - 55



## Rhytidectomy Scissors

56 - 57



## Nasal Scissors

58



## Tenotomy & Iris Scissors

59



## Fine Scissors

60

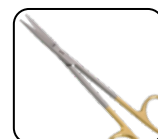

## Blepharoplasty & Dermal Naevus Scissors

61



## Wire Scissors

61 - 62



## Stitch & Bandage Scissors

62 - 63



## Micro Scissors

64

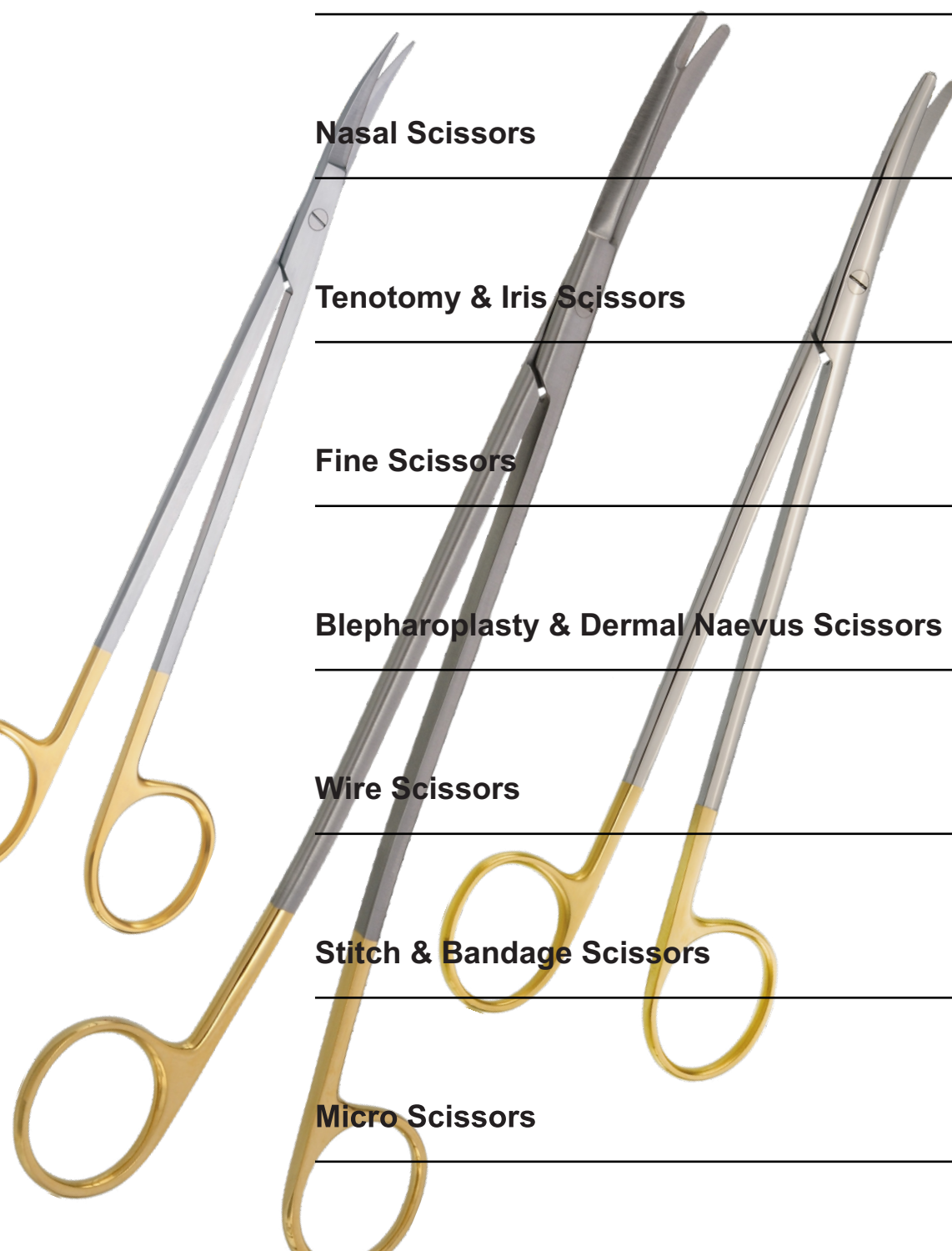
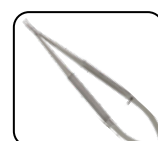

# Scissors

Operating Scissors, Dissecting Scissors

# SURGIXA

## Operating Scissors

Length 5½" (14 cm)

Standard	TC	Tip	Shape
510-014	510-514	Blunt/Blunt	Straight
510-015	510-515	Blunt/Blunt	Curved
510-024	510-524	Sharp/Blunt	Straight
510-025	510-525	Sharp/Blunt	Curved
510-034	510-534	Sharp/Sharp	Straight
510-035	510-535	Sharp/Sharp	Curved



## MAYO Dissecting Scissors

Standard	TC	SuperCut	Shape	Length
	510-580		Straight	5½" (14 cm)
	510-581		Curved	5½" (14 cm)
510-082	510-582	510-5082	Straight	6¾" (17 cm)
510-083	510-583	510-5083	Curved	6¾" (17 cm)

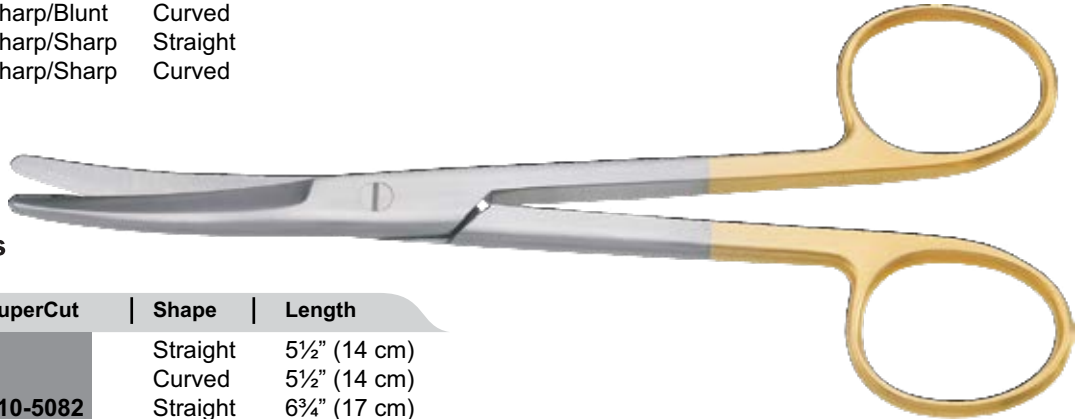

## MAYO-NOBLE Dissecting Scissors

Length 6¾" (17 cm)

	TC	Shapes	Length
	509-02817	Straight	6¾" (17 cm)
	509-02917	Curved	6¾" (17 cm)



## KILNER Dissecting Scissors

Curved

Standard	TC	SuperCut	Length
510-17413	509-17413	510-517413	5¼" (13 cm)

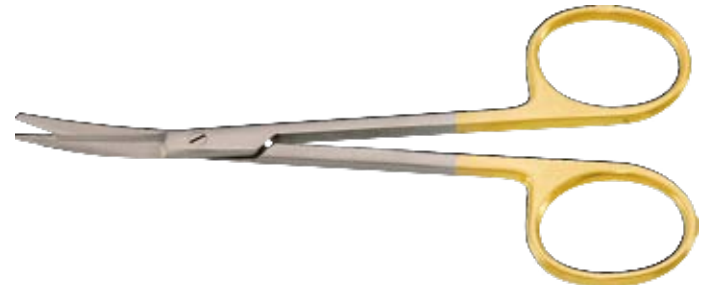

## KELLY Scissors

Length 6¼" (16 cm)

Standard	TC	Shape
510-350	509-03216	Straight
510-351	509-03316	Curved



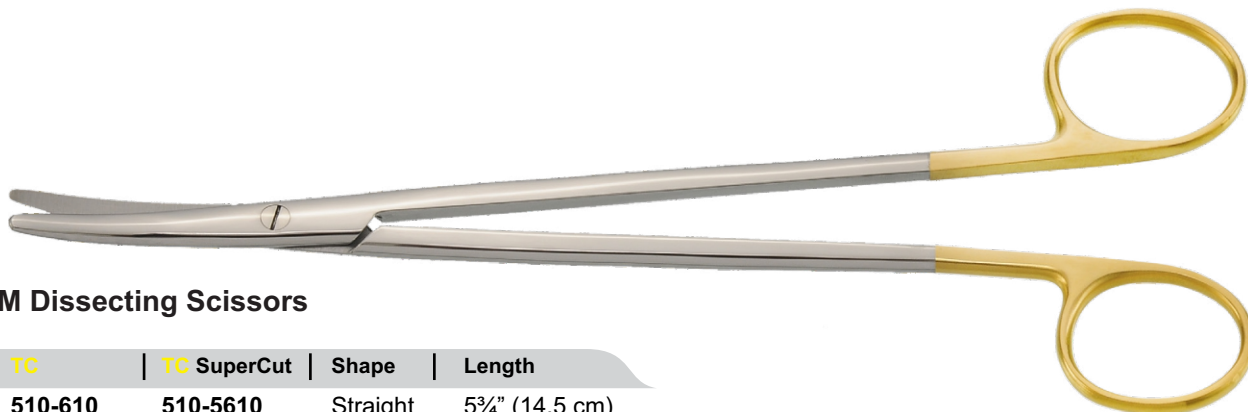

**METZENBAUM Dissecting Scissors**

Standard	TC	TC SuperCut	Shape	Length
510-110	510-610	510-5610	Straight	5¾" (14.5 cm)
510-111	510-611	510-5611	Curved	5¾" (14.5 cm)
510-120	510-620	510-5620	Straight	7" (18 cm)
510-121	510-621	510-5621	Curved	7" (18 cm)
510-122	510-622	510-5622	Straight	8" (20.5 cm)
510-123	510-623	510-5623	Curved	8" (20.5 cm)
510-124	510-624	510-5624	Straight	9" (23 cm)
510-125	510-625	510-5625	Curved	9" (23 cm)

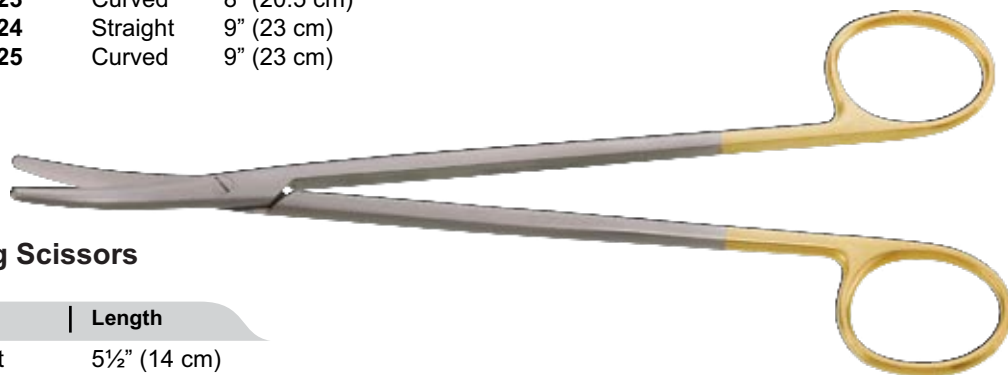

**METZENBAUM Fino Dissecting Scissors**

	TC	Shape	Length
	510-630	Straight	5½" (14 cm)
	509-36018	Straight	7" (18 cm)
	509-36118	Curved	7" (18 cm)
	509-36020	Straight	8" (20 cm)
	509-36120	Curved	8" (20 cm)
	509-36023	Straight	9" (23 cm)
	510-36123	Curved	9" (23 cm)

**BABY-METZENBAUM Dissecting Scissors**

Length 4½" (11.5 cm)

Standard	Shape
510-33011	Straight
510-33111	Curved



**LEXER-BABY Dissecting Scissors**

Length 4" (10 cm)

Standard	Shape
510-30110	Curved





**GORNEY Face-Lift Scissors**

serrated blades

Standard	TC	TC SuperCut	Shape	Length
510-44414			Curved	5½" (14 cm)
510-44619	509-44619	509-544619	Straight	7½" (19 cm)
510-44719	509-44719	509-544719	Curved	7½" (19 cm)
	509-44723		Curved	9" (23 cm)

**FREEMAN Face-Lift Scissors**

Length 7" (18 cm), serrated blades

Standard	TC	Length
510-44418	509-44418	Straight
510-44518	509-44518	Curved

**FREEMAN-GORNEY Face-Lift Scissors**

Length 7" (18.5 cm), serrated blades

TC	TC SuperCut	Shape
509-44218	509-544218	Straight
509-44318	509-544318	Curved

**KAYE-FREEMAN Face-Lift Scissors**

Length 7" (18 cm), serrated blades, delicate

TC	SuperCut	Shape
509-45218	510-545218	Straight
509-45318	510-545318	Curved

**KAYE Face-Lift Scissors**

serrated blades, curved

Standard	TC	Shape
510-45111	509-45111	4½" (11.5 cm)
510-45115	509-45115	6" (14.5 cm)
510-45118	509-45118	7" (18 cm)
510-45123	509-45123	9" (23 cm)



# Scissors

Rhytidectomy Scissors, Wire Scissors

# SURGIXA

## REES Face-Lift Scissors

Serrated blades

TC	Shape	Length
509-45417	Straight	6¾" (17 cm)
509-45517	Curved	6¾" (17 cm)
509-45420	Straight	8" (20 cm)
509-45520	Curved	8" (20 cm)



## ASTON Face-Lift Scissors

Serrated blades, curved

TC	Length
509-45917	6¾" (17 cm)
509-45920	8" (20 cm)



## WILKINSON Face-Lift Scissors

Length 7¾" (19 cm), Duckbill tip

TC	Shape
509-45719	Curved

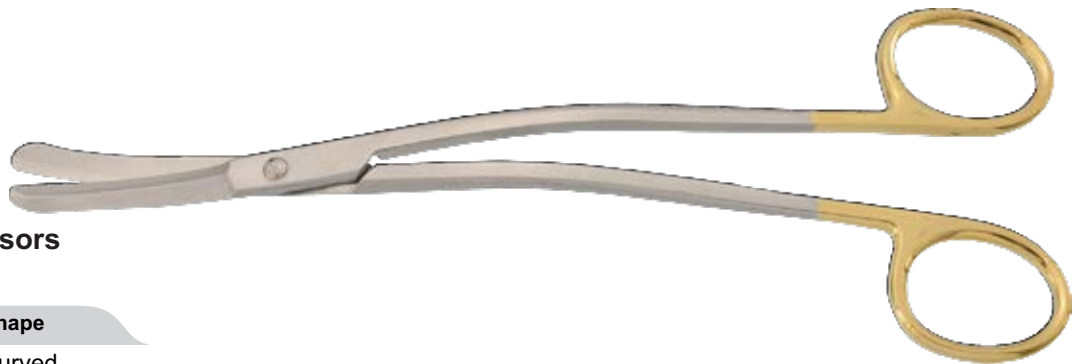

## DAVIS Face-Lift Scissors

Length 7" (18 cm), serrated blades

TC	Shape
509-44918	Curved



## CASTANARES Wire Scissors

Length 6¾" (16 cm)

TC	Shape
509-44016	Straight



**FOMON Lower Lateral Scissors**

strongly curved

Standard	Length
510-32013	5½" (14 cm)

**FOMON Nasal / Dorsal Scissors**  
Length 5¾" (14.5 cm), one blade serrated

Standard	TC	Shape
510-40015	509-40015	Angled

**COTTLE Nasal / Dorsal Scissors**  
Length 6¾" (17 cm), one blade serrated, Angled

Standard	TC	SuperCut
510-40616	509-40616	510-540616

**KNIGHT Nasal Scissors**

Serrated, Angled

TC	Length
509-40218	7" (18 cm)

**JOSEPH Nasal Scissors**

sharp/sharp

Standard	Shape	Length
510-170	Straight	5½" (14 cm)
510-171	Curved	5½" (14 cm)
510-172	Straight	6¼" (16 cm)
510-173	Curved	6¼" (16 cm)



# Scissors

Tenotomy Scissors, Iris Scissors

# SURGIXA

## REYNOLDS Tenotomy & Facelift Scissors

blunt/blunt

Standard	Shape	Length
510-160	Straight	6" (15 cm)
510-161	Curved	6" (15 cm)
510-163	Curved	7" (18 cm)



## STEVENS Tenotomy Scissors

Standard	TC	SuperCut	TC SuperCut	Shape	Tips	Length
510-410	509-410	510-5410	509-5410	Straight	Sharp/Sharp	4¼" (11 cm)
510-411	509-411	510-5411	509-5411	Curved	Sharp/Sharp	4¼" (11 cm)
510-412	509-412	510-5412	509-5412	Straight	Blunt/Blunt	4¼" (11 cm)
510-413	509-413	510-5413	509-5413	Curved	Blunt/Blunt	4¼" (11 cm)
510-414				Straight	Sharp/Sharp	5½" (14 cm)
510-415	509-415	510-5415	509-5415	Curved	Sharp/Sharp	5½" (14 cm)
510-416				Straight	Sharp/Sharp	6¼" (16 cm)
510-417	509-417	510-5417	509-5417	Curved	Sharp/Sharp	6¼" (16 cm)

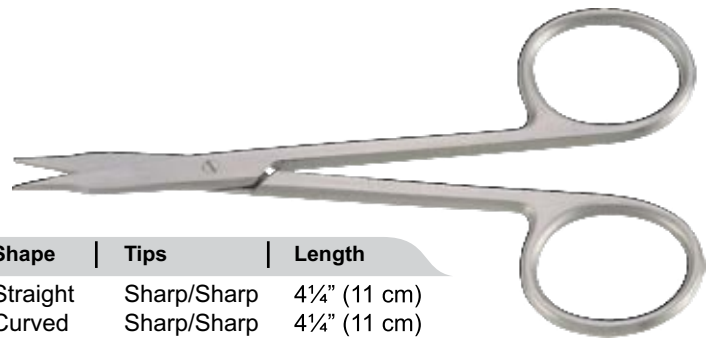

## IRIS Scissors

Sharp/Sharp

Standard	Shape	Length
510-402	Straight	4⅛" (10 cm)
510-390	Straight	4½" (11.5 cm)
510-391	Curved	4½" (11.5 cm)

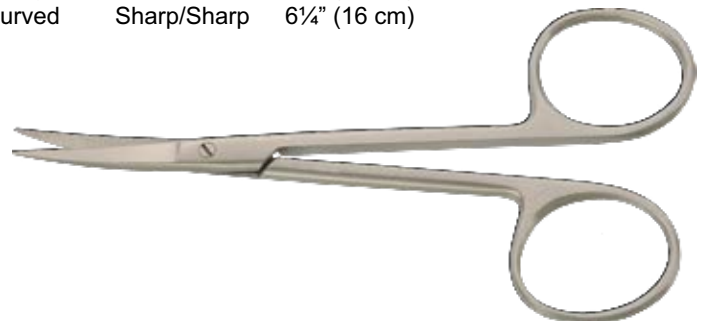

## IRIS Scissors

delicate, round shanks & screw joint, sharp/sharp

Standard	TC	SuperCut	Shape	Length
510-40411	510-41011	510-41411	Straight	4½" (11.5 cm)
510-40511	510-41111	510-41511	Curved	4½" (11.5 cm)



## IRIS Ribbon Scissors

sharp/sharp

Standard	Shape	Length
510-114209	Straight	3½" (9 cm)
510-114309	Curved	3½" (9 cm)
510-114210	Straight	4" (10 cm)
510-114310	Curved	4" (10 cm)



**STRABISMUS Scissors**

Length 4½" (11.5 cm)

Standard	TC	SuperCut	Shape
510-420	509-16011	510-516011	Straight
510-421	509-16111	510-516111	Curved



**SEALY Scissors**

Length 4¾" (12 cm), General purpose scissors

Standard	Shape
510-43212	Straight
510-43312	Curved

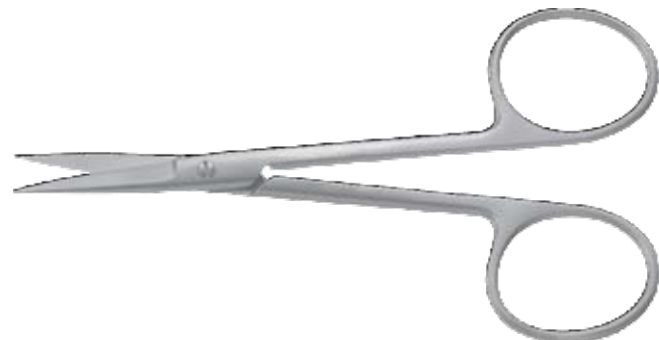

**SHEA Fine Scissors**

delicate, curved, sharp

Standard	Length
510-43412	4¾" (12 cm)



**KAYE Blepharoplasty Scissors**

ribbon handle, serrated

Standard	Shape	Length
510-45911	Curved	4½" (11.5 cm)

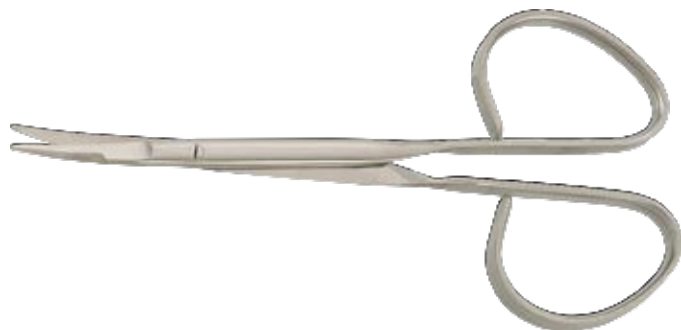

**GRADLE Scissors**

Length 4" (10 cm), sharp

Shape	Ribbon Handle
Straight	510-04410
Curved	510-04510

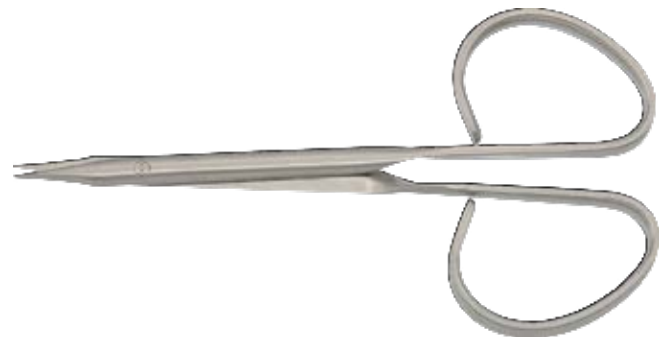



# Scissors

Blepharoplasty, Dermal Naevus, Wire Scissors

# SURGIXA

## Blepharoplasty Scissors

flat tips, one serrated blade

TC	Shape	Length
509-17911	Curved	4½" (11.5 cm)



## GUNTER (BIRO) Dermal Naevus Scissors

angled on flat, with sharp outside edges

	Length
510-407	4" (10.2 cm)

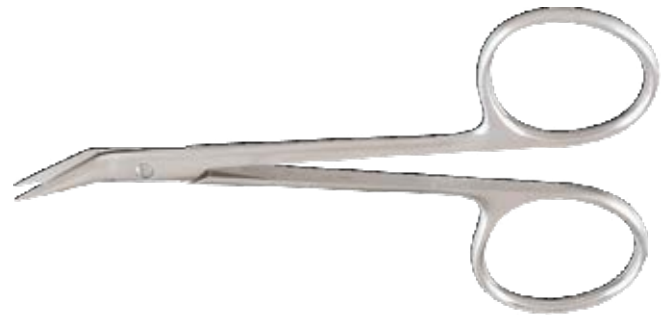

## GRADLE Scissors

Length 3¾" (9.5 cm), sharp

Standard	Shape
510-04409	Straight
510-04509	Curved

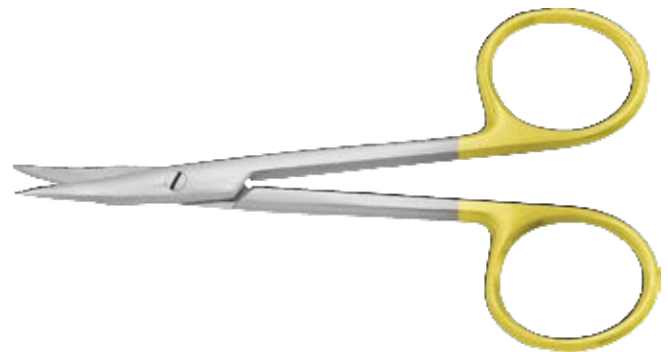

## WILMER Conjunctival and Utility Scissors

Length, 4" (10.2 cm), Angled on flat, serrated cutting edge

TC	Standard	Tip
509-409	510-409	Sharp/Sharp



## GREENBERG PAR Scissors

Length 4½" (11.5 cm)

TC	Shape
509-43611	Straight
509-43711	Curved



**PAR Scissors**

Length 4½" (11.5 cm)

TC	Shape
509-43911	Curved



**GOLDMAN FOX Gum Scissors**

Length 5" (13 cm)

TC	SuperCut	Shape
510-700	510-5700	Straight
510-701	510-5701	Curved



**Universal Wire Scissors**

one blade serrated

TC	Length
510-730	4¾" (12 cm)

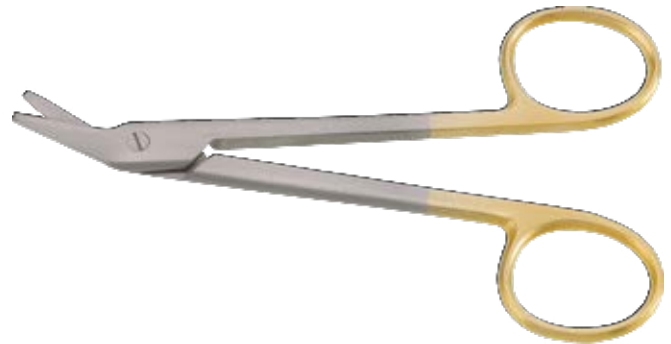

**LITTLER Stitch Scissors**

Length 5½" (14 cm), tip with eye for suture

Standard	Shape
512-20514	Curved



**LITTAUER Stitch Scissors**

Length 5½" (14 cm), one tip with hook for catching suture

Standard	Shape
510-210	Straight



## SPENCER Stitch Scissors

Standard	Side Curved	Length
510-200	510-201	3½" (9 cm)
510-202	510-203	5" (12.7 cm)



## O'BRIEN Stitch Scissors

Fine angled tip, 15 mm cutting edge

Standard	Length
510-221	4" (10 cm)
510-222	4¾" (12 cm)



## LISTER Bandage Scissors

Angled

Standard	Length
524-012	4½" (11.5 cm)
524-014	5½" (14 cm)
524-016	7¼" (18 cm)
524-018	8¼" (20 cm)



## KNOWLES Bandage Scissors

Length 5½" (14 cm)

Angled
524-021



## Universal Bandage Scissors

5¾" (14.5 cm)	7" (18 cm)	Color
524-076BK	524-080BK	Black
524-076RB	524-080RB	Royal Blue
524-076GN	524-080GN	Green
524-076PK	524-080PK	Pink
524-076RD	524-080RD	Red
524-076WE	524-080WE	White
524-076YW	524-080YW	Yellow





**Micro Scissors, with round handle**

Straight	Curved	Length
542-1372	542-1373	6" (15 cm)
542-1374	542-1375	7" (18 cm)
542-1376	542-1377	8¼" (21 cm)
542-1378	542-1379	9" (23 cm)

**VANNAS Micro Scissors**  
Length 3" (7.6 cm), 5 mm blade

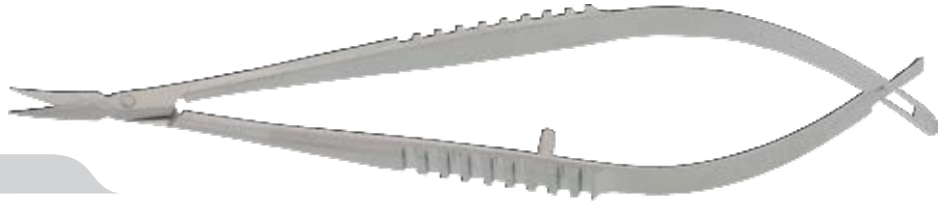

Straight	Curved
542-1400	542-1401

**WESTCOTT Micro Scissors**  
Length 4¼" (11 cm), 10 mm blade



Straight	Curved	
542-1390	542-1391	Sharp / Sharp

**WESTCOTT Stitch Scissors**  
Length 4 ¾" (12 cm), delicate blades

Straight	Curved	
542-1396	542-1397	Sharp / Sharp

**CASTROVIEJO Micro Scissors**  
Length 4" (10 cm)



Curved	
542-1381	Sharp / Sharp
542-1383	Blunt / Blunt

## Thumb & Tissue Forceps

66 - 68



## Polypus Forceps

69



## Atraumatic Forceps

69



## Iris & Fine Forceps

70



## Micro Forceps

71



## Jeweller's Forceps

71



## Splinter & Cilia Forceps

72







**Dressing Forceps**

Serrated	1 x Teeth	Length
512-032	512-132	4½" (11.5 cm)
512-034	512-134	5" (12.5 cm)
512-036	512-136	5½" (14.5 cm)
512-038	512-138	6¼" (16 cm)
512-040	512-140	7" (18 cm)
512-042	512-142	8" (20 cm)
512-044	512-144	10" (25.5 cm)
512-046	512-146	12" (30 cm)

**ADSON Dressing Forceps**

Serrated tip

Serrated	1 x 2 Teeth	Length
512-090	512-320	4¾" (12 cm)
512-091	512-321	6" (15 cm)



**ADSON Dressing Forceps**

TC

Serrated	Smooth	1 x 2 Teeth	Length
511-07012	511-07412	511-07212	4¾" (12 cm)
511-07015		511-07215	6" (15 cm)



**ADSON Micro Forceps**

delicate

Serrated	1 x 2 Teeth	Length
512-530	512-540	4¾" (12 cm)



**ADSON Micro Dressing Forceps**

Delicate, TC

Serrated	Smooth	Length
511-07612	511-07812	4¾" (12 cm)
511-07615		6" (15 cm)



**HORTON ADSON Tissue Forceps**

TC

	1 x 2 Teeth	Length
	511-06412	4¾" (12 cm)
	511-06415	6" (15 cm)



**DANIEL-ADSON Forceps**

spoon / cup shaped

	Length
510-32812	5" (12.5 cm)



# Forceps

Thumb & Tissue Forceps, Blepharoplasty Forceps

# SURGIXA

## ADSON-BROWN Tissue Forceps

7 x 7 Teeth

Straight	Angled to Side	7 x 7 Teeth	Length
512-330	512-331	511-06012	4¾" (12 cm)
512-334		511-06015	6" (15 cm)



## ADSON Tissue Forceps

Length 4¾" (12 cm), with tying platform

Serrated	Tip
512-25602	
512-25612	1 x 2 Teeth
512-25802	Delicate
512-25812	1 x 2 Teeth, Delicate



## GORNEY-ADSON Forceps

Length 4¾" (12 cm), TC

1 x 2 Teeth	Shapes
510-18612	diamond coated platform
510-18712	smooth platform



## ADSON-DeBAKEY Atraumatic Tissue Forceps

Length 4¾" (12 cm)

Straight	Angled
534-4900	534-4901



## PAR Forceps

TC	Length
510-17452	4¾" (12 cm)



## ADSON Blepharoplasty Forceps

with delicate hooks

TC	Length
510-44319	5" (13 cm)



with standard hooks and platform

TC	Length
510-44321	5" (13 cm)



## CASTROVIEJO Blepharoplasty Forceps

with extra fine hooks

TC	Length
510-44323	4¾" (12 cm)



# Forceps

Thumb & Tissue Forceps

# SURGIXA

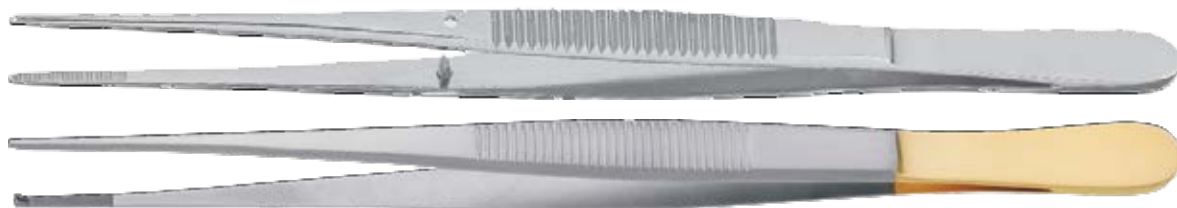

## SEMKEN Dressing Forceps

Serrated

Straight	1 x 2 Teeth	Length
512-112	512-362	6" (15 cm)
	512-0016	6¼" (16 cm)



## TAYLOR Forceps

Length 7" (17.5 cm), with dissector end

Shapes	Straight	Bayonet
Serrated	512-10217	512-10417
1 x 2 teeth	512-23217	512-23417



## POTTS-SMITH Dressing Forceps

TC	Length
511-4618	7" (18 cm)
511-4620	8" (20 cm)
511-4625	9¾" (25 cm)



## OEHLER Dressing Forceps

with TC platform

1 x 2 Teeth	Length
511-039	5" (13 cm)
511-040	5¼" (14 cm)
511-042	6¼" (16 cm)
511-044	7" (18 cm)
511-046	8" (20 cm)
511-048	10" (25 cm)



## GERALD Forceps

with TC platform, 1 x 2 teeth

Standard	Micro	Tip
511-1017	511-1217	6¾" (17 cm)



## GILLIES Tissue Forceps

Serrated

1 x 2 Teeth	Length
512-20415	6" (15 cm)

# Forceps

Polypus Forceps, Atraumatic Forceps

# SURGIXA

## McINDOE Tissue Forceps

Serrated



1 x 2 Teeth	Length
-------------	--------

512-20015	6" (15 cm)
-----------	------------

## CUSHING Forceps

Length 7" (18 cm), with TC platform



Straight	Angled	Bayonet
----------	--------	---------

511-1018	511-1218	511-3218
----------	----------	----------

## JANSEN-GRUENWALD Nasal Polypus Forceps

Bayonet



Serrated	Length
----------	--------

544-380	6¼" (16 cm)
---------	-------------

## LUCAE Ear Polypus Forceps

Length 5½" (14 cm), Bayonet



Shape
-------

544-370	Serrated
---------	----------

## TROELTSCH (WILDE) Ear Polypus Forceps



Angled	Length
--------	--------

544-362	4¾" (12 cm)
---------	-------------

## DEBAKEY Atraumatic Tissue Forceps



Length	1.5 mm Tip	2 mm Tip	2.7 mm Tip	3.5 mm Tip
--------	------------	----------	------------	------------

6" (15 cm)	534-3415	534-3615	534-3815	
6¼" (16 cm)	534-3416	534-3616	534-3816	534-4016
7¾" (19 cm)	534-3420	534-3620	534-3820	534-4020
9½" (24 cm)	534-3424	534-3624	534-3824	534-4024
12" (30 cm)	534-3430	534-3630	534-3830	534-4030





**GREEN Fixation Forceps**

Length 4" (10.5 cm)

Tip Width	With lock	Without lock
5 mm	543-07805	543-07605
10 mm	543-07810	543-07610



**CASTROVIEJO Forceps**

Length 4 1/4" (10.5 cm), with platform, wide handle

Tip Width	1 x 2 Teeth
0.12 mm	543-14901
0.3 mm	543-14903
0.5 mm	543-14905
0.9 mm	543-14909
1.5 mm	543-14915



**GRAEFE (CASTROVIEJO)-BROWN Forceps**

with multiple teeth

Straight	Length
510-18851	4 3/4" (11.5 cm)



**ADSON-GRAEFE Tissue Forceps**

with multiple teeth

Straight	Length
510-20012	4 3/4" (12 cm)



**GRAEFE Iris Forceps**

Serrated	1 x 2 Teeth	Length
542-940	542-950	4" (10 cm)



**BISHOP-HARMON Eye Forceps**

Length 3 1/4" (8.5 cm)

	Tip Width
542-1020	0.8 mm, serrated
542-1030	0.8 mm, 1 x 2 teeth
542-1040	0.5 mm, fine serrated
542-1050	0.5 mm, fine 1 x 2 teeth



**McPHERSON Suture Forceps**

Length 4" (10 cm), with platform, 7 mm tip

Straight	Angled	Teeth
543-22210	543-22010 543-21010	1 x 2 Teeth

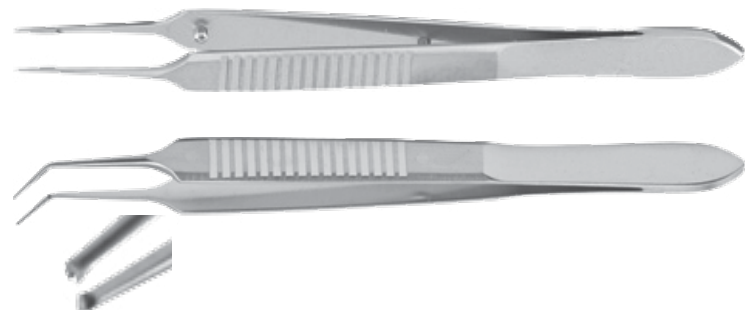

**BONNEY Forceps**

Length 6 3/4" (17 cm), with TC platform

TC	Tip
511-02217	1 x 2 teeth







## Micro Dressing and Suture Forceps

Round handle, diamond coated jaws

	Shape	Tip	Length	
<b>513-56015</b>	Straight	6.0 x 0.4 mm	6" (15 cm)	
<b>513-56018</b>	Straight	6.0 x 0.4 mm	7" (18 cm)	
<b>513-56115</b>	Curved	6.0 x 0.4 mm	6" (15 cm)	
<b>513-56118</b>	Curved	6.0 x 0.4 mm	7" (18 cm)	

## Micro Vessel Dilating Forceps

Flat handle, popular in Hand Surgery



Length	Ø 0.2 mm	Ø 0.3 mm	Shape
4¼" (11 cm)	<b>511-36120</b>	<b>511-36130</b>	Straight
4¼" (11 cm)	<b>511-36620</b>	<b>511-36630</b>	10° Angled handle
7" (18 cm)	<b>511-36820</b>	<b>511-36830</b>	Straight

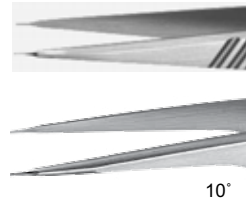

## Micro Suture Tying Forceps

Round handle with guide pin, with platform

Length	Tip	Straight	Curved
4¾" (12 cm)	0.3 mm	<b>511-10212</b>	<b>511-10312</b>
6" (15 cm)	0.3 mm	<b>511-10215</b>	<b>511-10315</b>
7" (18 cm)	0.6 mm	<b>511-10418</b>	<b>511-10518</b>

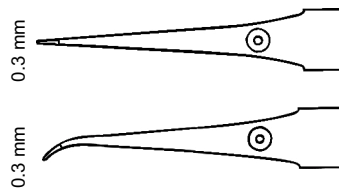

## Jeweller's Forceps



	Fig	Tip	Length	
<b>512-3061</b>	Fig. 1	4½" (11.5 cm)	straight, standard	
<b>512-3063</b>	Fig. 3	4½" (11.5 cm)	straight, delicate	
<b>512-30633</b>	Fig. 3C	4¼" (10.5 cm)	straight, delicate	
<b>512-3064</b>	Fig. 4	4¼" (11.0 cm)	straight, very fine	
<b>512-3065</b>	Fig. 5	4¼" (11.0 cm)	straight, ultra fine	
<b>512-30651</b>	Fig. 5A	4¼" (11.0 cm)	angled, very fine	
<b>512-30656</b>	Fig. 5/45°	4¼" (11.0 cm)	angled 45°, delicate	
<b>512-30658</b>	Fig. 5/90°	4¼" (11.0 cm)	angled 90°, ultra fine	
<b>512-30655</b>	Fig. 5/45°	4¼" (11.0 cm)	angled 45°, delicate	
<b>512-3067</b>	Fig. 7	4¼" (11.0 cm)	curved, delicate	

**FEILCHENFELD Splinter Forceps**

	Length
512-654	4½" (11.5 cm)



**Splinter Forceps**

	Length
512-640	4" (10 cm)



**WALTER-CARMALT Splinter Forceps**

Length 4¼" (10.5 cm)

	Serrated	Length
512-670	straight	
512-671	angled tip	



**RALK Splinter Forceps**

Length 6" (15 cm)

	Serrated	Length
512-720	straight	
512-721	angled tip	



**LITTAUER Cilia Forceps**

	Length	Tip
512-590	3½" (8.5 cm)	flat smooth
512-592	3½" (9 cm)	angled serrated

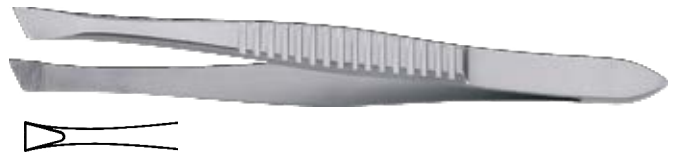

**COTTLE Skin Grasping Forceps**

with fixation screw

	Length
546-75011	4½" (11 cm)



**DESMARRES Chalazion Clamp**

Length 3½" (9 cm), with fixation screw

	Size	Tip
542-1300	small	11 x 17 mm
542-1302	medium	12 x 23 mm
542-1304	large	17 x 28 mm

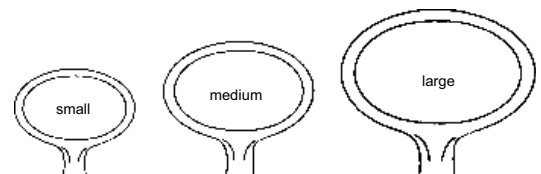

**Hemostatic Forceps**

74 - 76

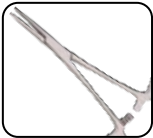

**Towel Clamps**

77



**Sponge Forceps**

78

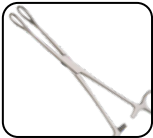

**Tubing Clamps**

78

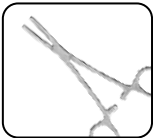

**HARTMANN-MOSQUITO Hemostatic Forceps**  
Length 4" (10 cm)

	Straight	Curved
serrated	514-030	514-031
delicate	514-032	514-033
1 x 2 teeth	514-034	514-035

**HALSTEAD-MOSQUITO Micro Hemostatic Forceps**

Length	Straight	Curved
4¾" (12 cm)	514-066	514-067
5½" (14 cm)	514-072	514-073

Delicate

Length	Straight	Curved
5¼" (13.5 cm)	514-076	514-077

**JULIAN MOSQUITO Forceps**

Length	Curved
7½" (19 cm)	514-08119
9¼" (23.5 cm)	514-08123

**KELLY Hemostatic Forceps**

Length 5½" (14 cm)

	Straight	Curved
half serrated	514-090	514-091

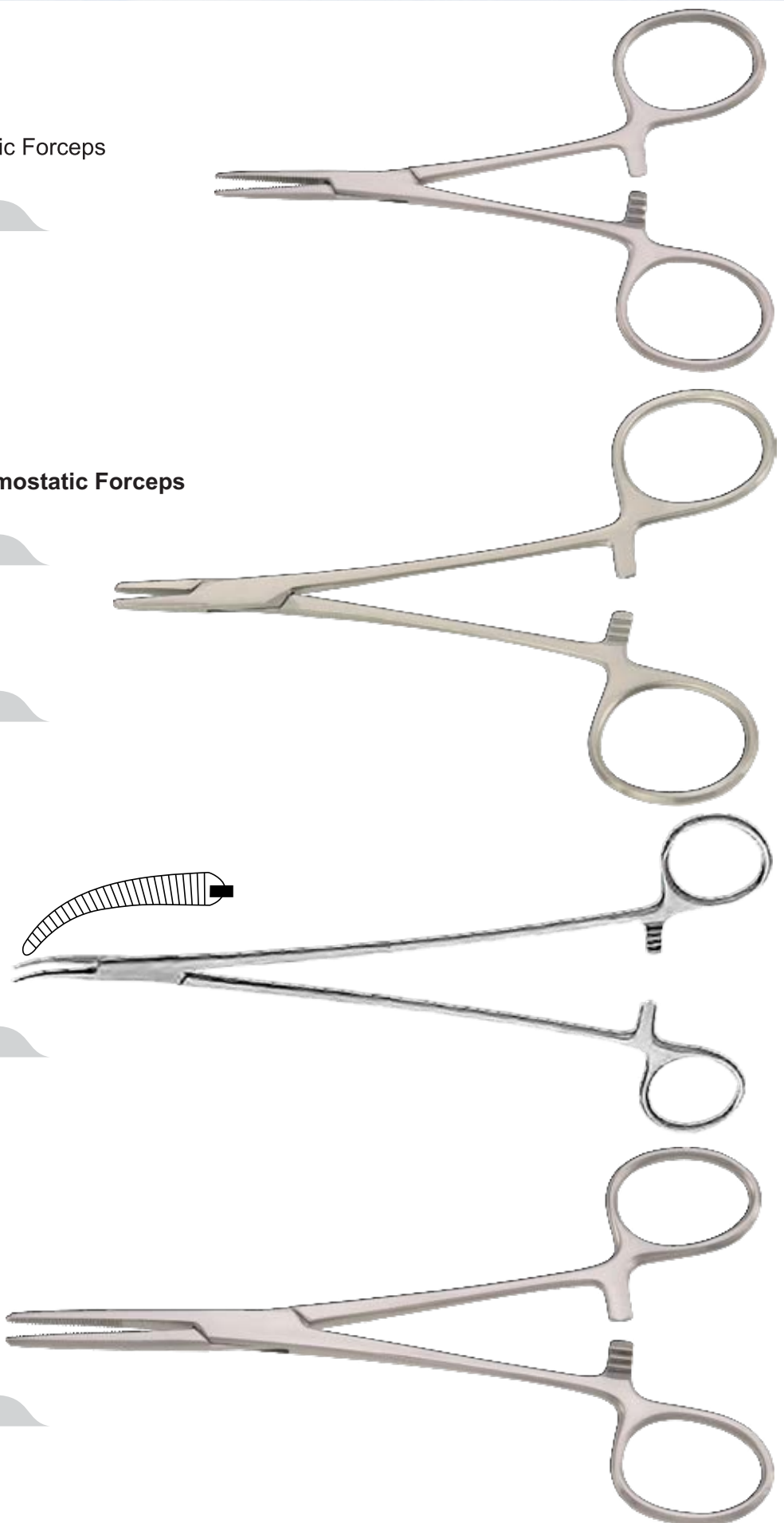

**CRILE Hemostatic Forceps**

	Straight	Curved
5½" (14 cm)	514-100	514-101



**RANKIN-CRILE Hemostatic Forceps**

Length 6¼" (16 cm)

	Straight	Curved
serrated	514-110	514-111



**ROCHESTER-PEAN Hemostatic Forceps**

serrated

	Straight	Curved
5½" (14 cm)	514-210	514-211
6¼" (16 cm)	514-212	514-213
7" (18 cm)	514-214	514-215
8" (20 cm)	514-216	514-217



**KOCHER (OCHSNER) Hemostatic Forceps**

serrated, with 1 x 2 teeth

	Straight	Curved
5½" (14 cm)	514-230	514-231
6¼" (16 cm)	514-232	514-233
7" (18 cm)	514-234	514-235
8" (20 cm)	514-236	514-237





**ADSON Hemostatic Forceps**

serrated

Length	Curved
--------	--------

7¼" (18.5 cm)	514-27118
---------------	-----------

**MIXTER Hemostatic Forceps**

Half serrated, strongly curved at right angle

Length	Right Angled
--------	--------------

5½" (14 cm)	514-43014
6" (15 cm)	514-43015
6¾" (16 cm)	514-43016
7½" (19 cm)	514-43019
9" (23.5 cm)	514-43023

**ALLIS-BABY Tissue Forceps**

Length	4 : 5 Teeth
--------	-------------

4½" (12 cm)	552-010
-------------	---------

**Tissue Forceps**

multiple teeth

Length	4 : 5 Teeth	5 : 6 Teeth
--------	-------------	-------------

4½" (11.5 cm)	552-014	
5½" (14.5 cm)	552-019	
6" (15 cm)	552-020	552-030



**LAHEY Vulsellum Forceps**

Sharp prongs

Length	3 x 3 Prongs
6" (15 cm)	552-5215

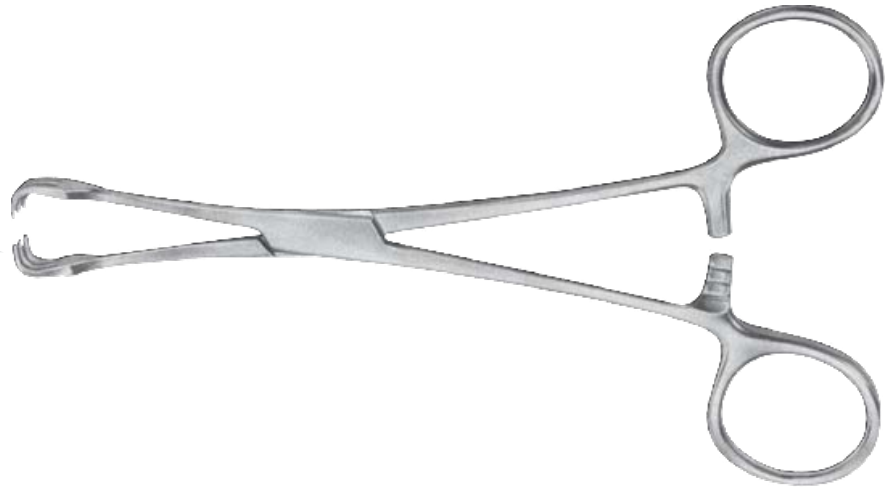

**BACKHAUS Towel Clamps**

Length	
3½" (9 cm)	514-941
4¼" (11 cm)	514-942
5¼" (13.5 cm)	514-945

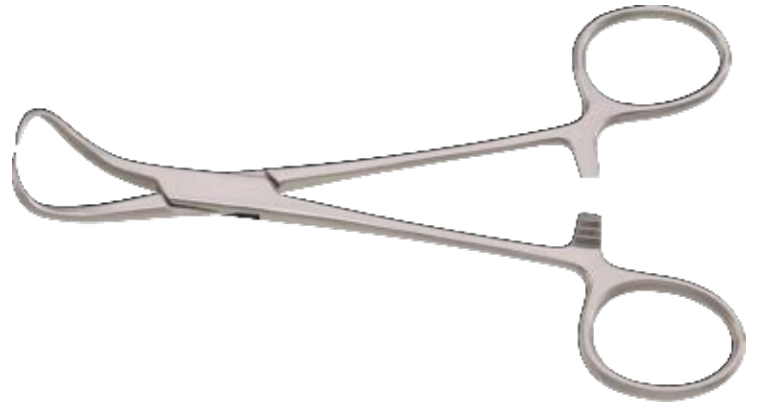

**LORNA-EDNA Towel Clamp**

Length	
4" (10 cm)	514-960
5¼" (13.5 cm)	514-963

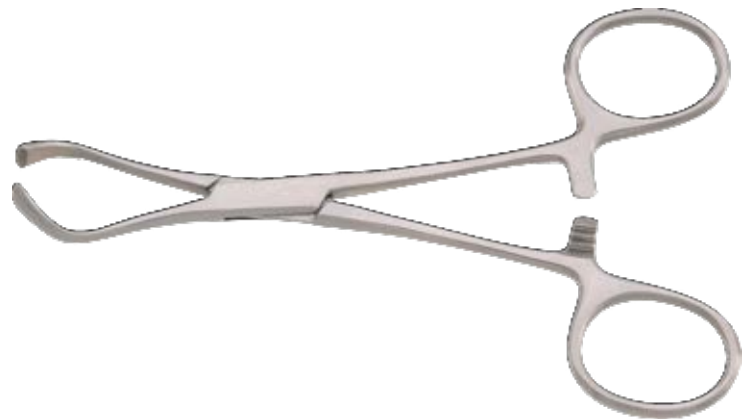

**JONES Towel Clamps**

Length	
3½" (9 cm)	514-1030



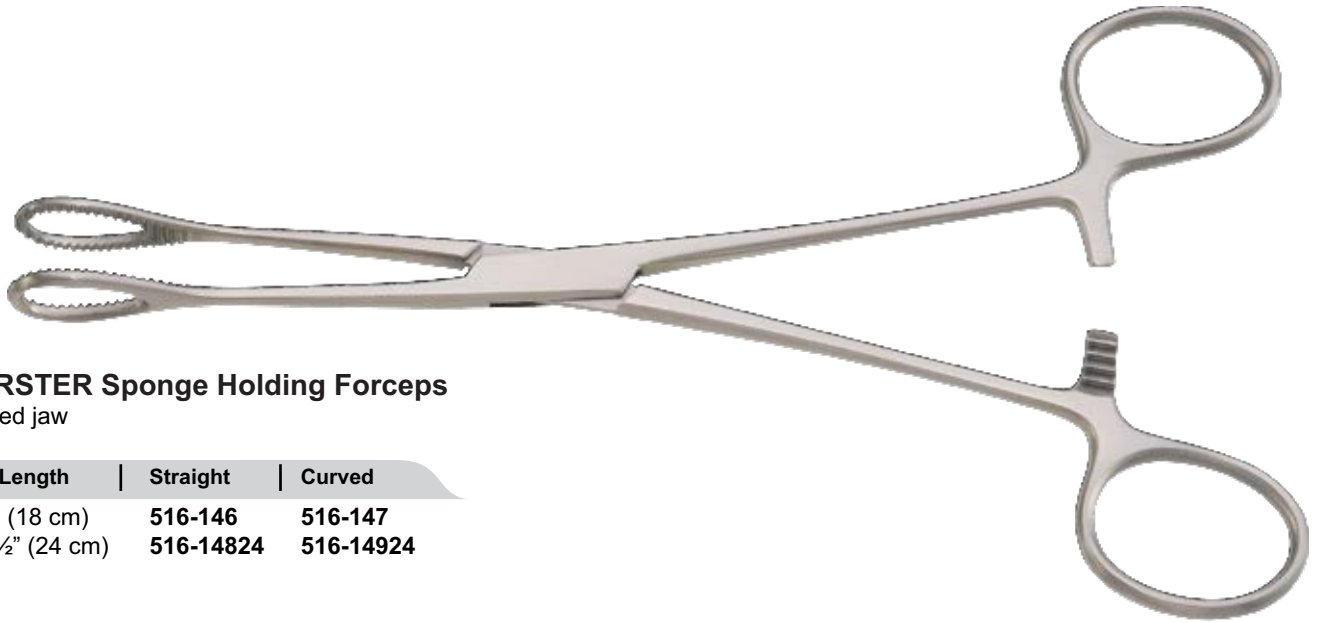

**FOERSTER Sponge Holding Forceps**  
Serrated jaw

Length	Straight	Curved
7" (18 cm)	<b>516-146</b>	<b>516-147</b>
9½" (24 cm)	<b>516-14824</b>	<b>516-14924</b>

**USA MODEL Tubing Clamps**  
Serrated

Length	With guard	Without guard
6" (15 cm)	<b>514-1060</b>	<b>514-1070</b>
7" (18 cm)	<b>514-1062</b>	<b>514-1072</b>



**Needle Holders**

80 - 83



**Needle Holders / Scissors Combis**

82



**Micro Needle Holders**

83



**DERF Needle Holders**  
TC

Length	Serrated	Smooth	Serrated
4¾" (12 cm)	<b>521-010</b>	<b>521-008</b>	522-010

**WEBSTER (BABY) Needle Holders**  
TC

Length	Serrated	Smooth	Serrated
4¾" (12 cm)	<b>521-018</b>	<b>521-016</b>	522-032

**WEBSTER Needle Holders**  
TC

Length	Serrated	Smooth	Serrated	Smooth
5" (13 cm)	<b>521-022</b>	<b>521-020</b>	522-031	522-030

**HALSEY Needle Holders**  
TC

Length	Serrated	Smooth
5" (13 cm)	<b>521-030</b>	<b>521-032</b>

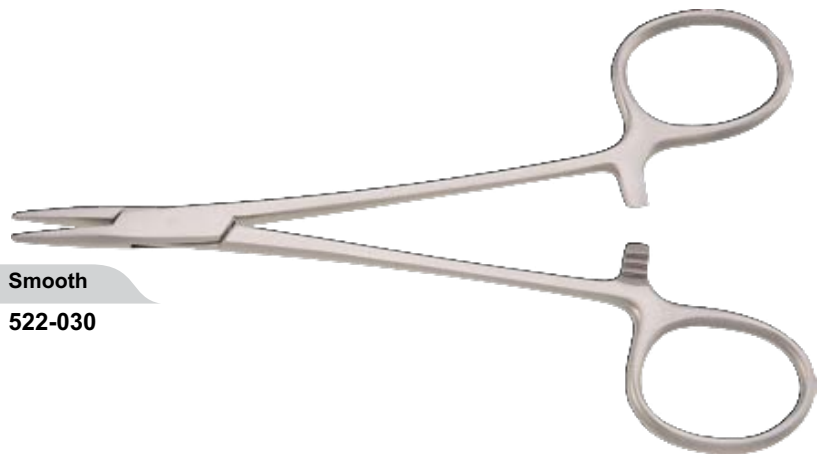



**PAR Needle Holders**

Extremely delicate Type

Length	TC
4½" (11.5 cm)	521-14011
5" (13 cm)	521-14013

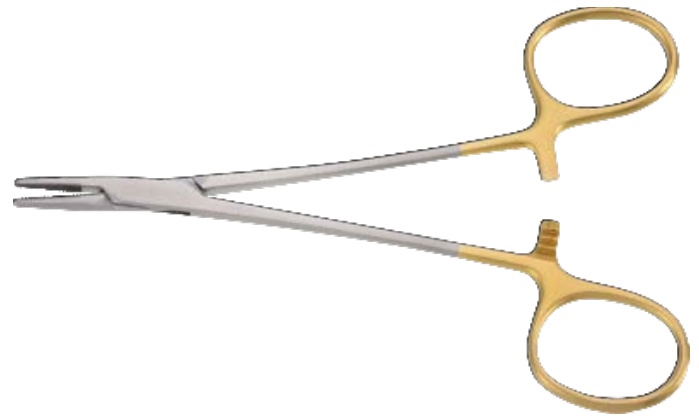

**NEIVERT (OFFSET) Needle Holder**  
with one offset ring

Length	TC
5" (13 cm)	521-02013

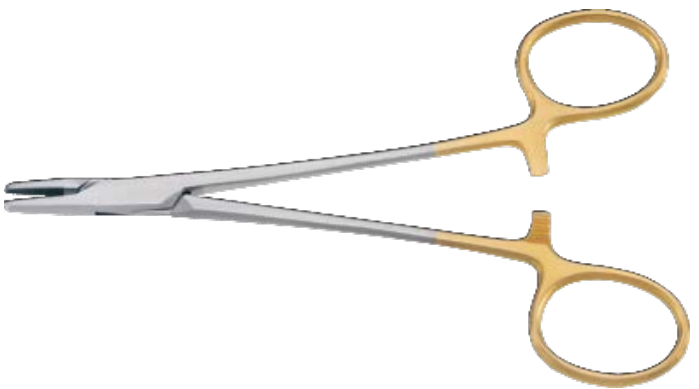

**BAUMGARTNER Needle Holders**

Length	TC
5½" (14 cm)	521-042

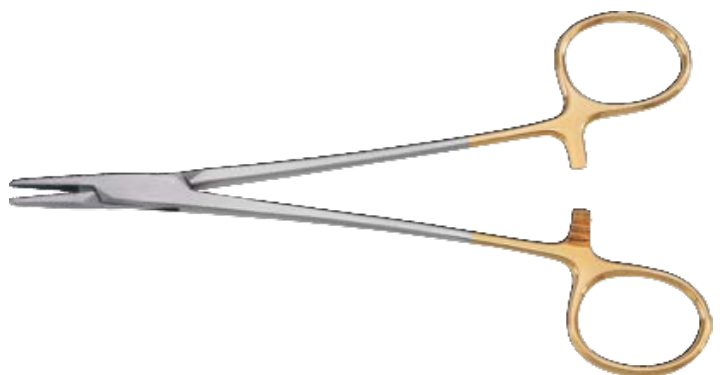

**CRILE WOOD Needle Holders**

TC

Length	Serrated	Smooth
6" (15 cm)	521-02415	521-02215
7" (18 cm)	521-02418	
8" (20 cm)	521-02420	
9" (23 cm)	521-02423	

**MAYO HEGAR Needle Holders**

TC

Length	TC	Standard
5½" (14 cm)		522-100
6¼" (16 cm)	521-060	522-102
7" (18 cm)	521-062	522-104
8" (20 cm)	521-064	522-106

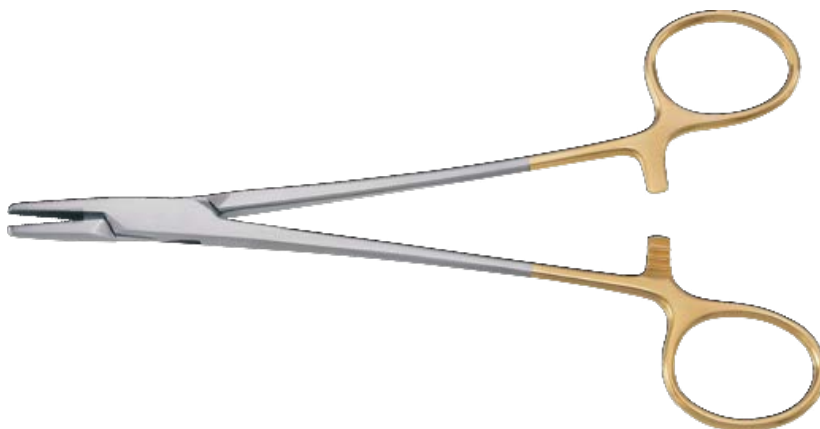

**SWEDISH Needle Holder**

TC

Length	TC
6¼" (15 cm)	521-16614

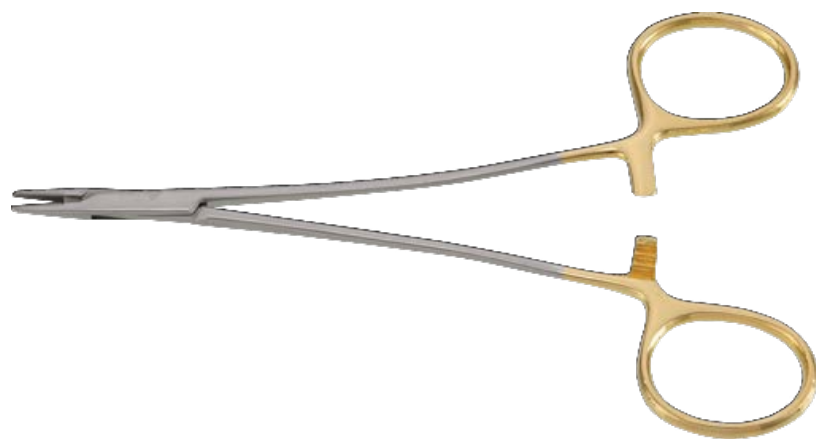

**GILLIES Needle Holders**

TC, Needle holder and scissors combination

Length	Serrated
4¾" (11 cm)	521-06011
5¼" (13 cm)	521-06013
6¼" (16 cm)	521-06016



**OLSEN HEGAR Needle Holders**

Needle holder & scissors combination, cut screw joint

Length	Serrated	Smooth	Left Handed	Cross Serrated	Smooth
4¾" (12 cm)	521-22612	521-22812	521-22712	522-27612	522-27812
5½" (14 cm)	521-22614	521-22814	521-22714	522-27614	
6¼" (16 cm)				522-27616	
6½" (16.5 cm)	521-22617		521-22717		
7" (18 cm)	521-22618		521-22718	522-27618	

cut screw joint

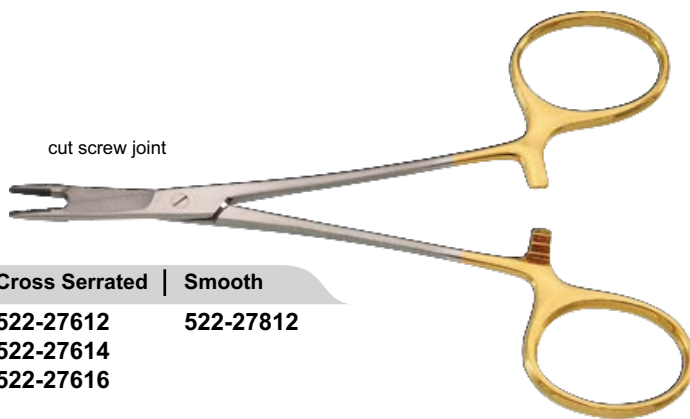

**Micro Vascular Needle Holders**  
Serrated

Length	TC
6" (15 cm)	521-11615
7" (18 cm)	521-11618
8" (20 cm)	521-11620

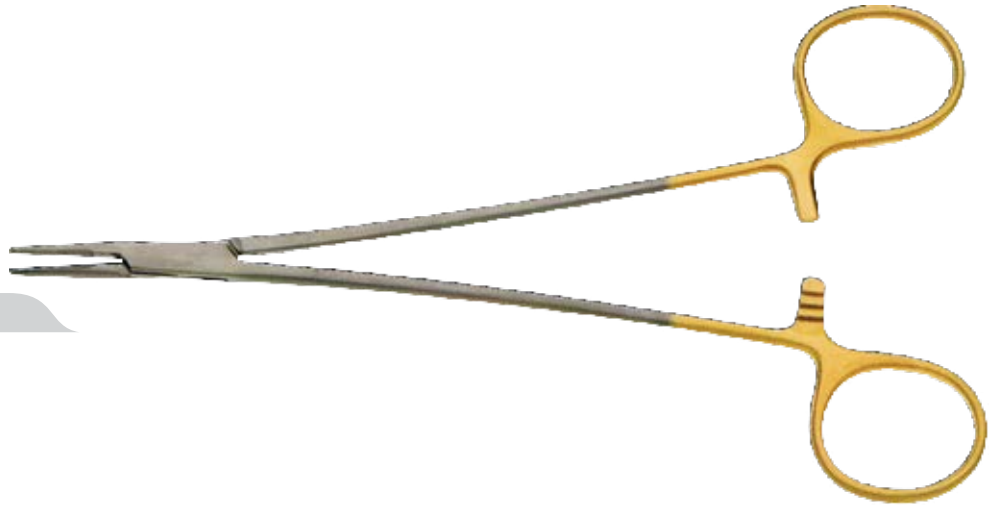

**EUPHRATE-PASQUE Needle Holders**  
extremely delicate, angled shanks

Length	TC
5½" (14 cm)	521-12414
6" (15 cm)	521-12415
7" (18 cm)	521-12418

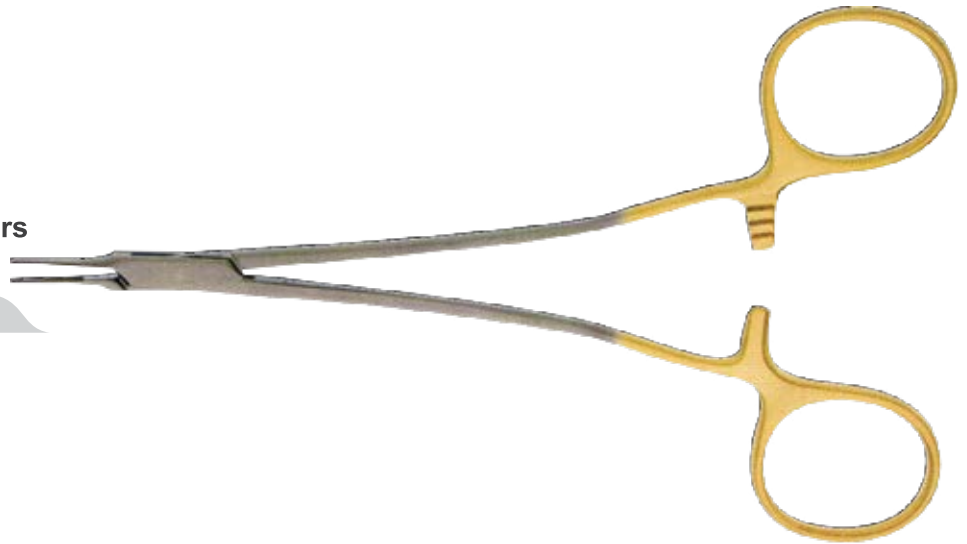

**LEMMON Needle Holders**  
TC

Length	TC
6¾" (17 cm)	521-10617

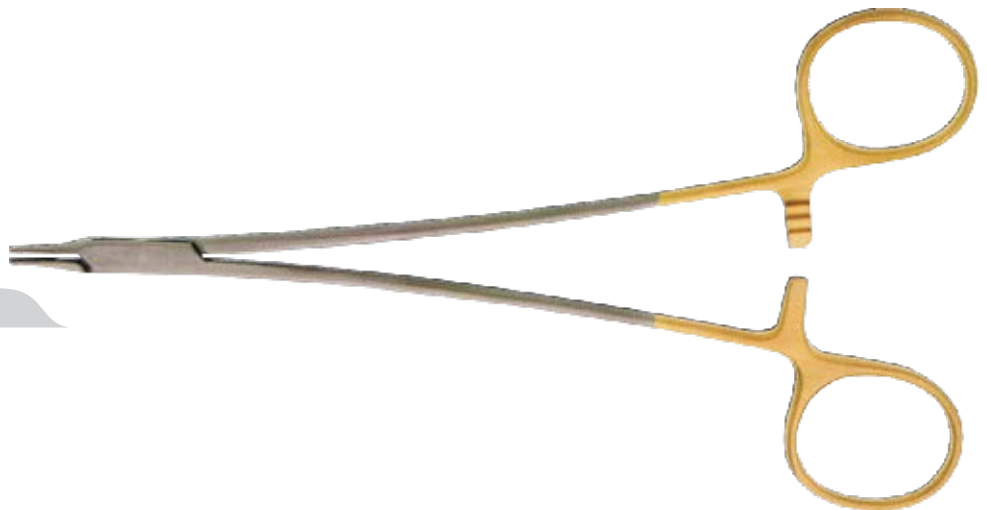

**CASTROVIEJO Micro Needle Holders**

with lock, TC cross-serrated, flat handle

Straight	Curved	Length
521-25214	521-25314	5½" (14 cm)
521-25218	521-25318	7" (18 cm)



Length 5½" (14 cm), TC smooth, flat handle

With Lock	Shape
521-25614	Straight
521-25714	Curved



**CASTROVIEJO Micro Needle Holders**

Length 5½" (14 cm), smooth jaws, flat handles

With Lock	Without Lock	Shape
521-24814	521-24614	Straight
521-24914	521-24714	Curved



**BARRAQUER Micro Needle Holders**

Length 5" (13 cm), smooth jaws, round handles

With Lock	Without Lock	Shape
521-40213	521-40013	Straight
521-40313	521-40113	Curved



**Micro Needle Holders**

without catch, smooth jaws, round handle

Straight	Curved	Length
521-40015	521-40115	6" (15 cm)

## Suction Tubes

86



## Scalpels & Knives

87 - 88



## Dermatomes

89



## Hollowware

90







**YANKAUER Suction Tubes**

Length 11¼" (28.5 cm), with tube olive

Without Light Guide	With Light Guide	Central bore
506-0300	506-0308	Ø 2.0 mm

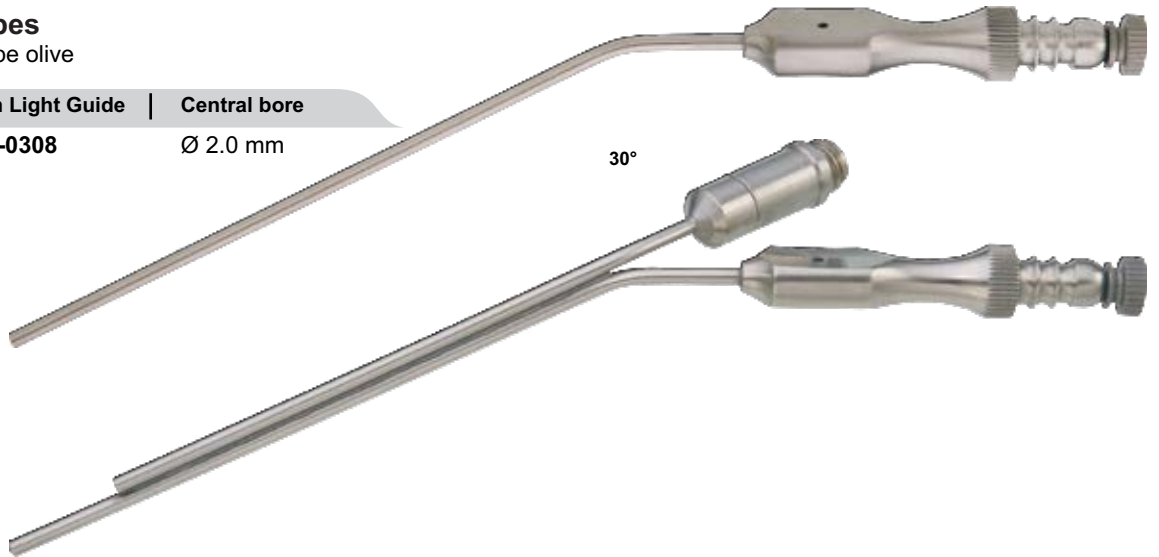

30°

**FRAZIER (FERGUSSON) Suction Tubes**

Total Length 7" (18 cm), Working Length 4¼" (11 cm), 30° Angled, with finger cutoff and obturator

Without Light Guide	With Light Guide	Fig.
530-0229		4
530-0228		5
530-0230		6
530-0231		7
530-0232	530-1232	8
530-0233		9
530-0234	530-1234	10
530-0235		11
530-0236	530-1236	12
530-0238		14



**BARON (SCHUKNECHT) Suction Tubes**

with finger cutoff and stylet

3" (7.5 cm)	Diameter
506-3703	Ø 1.0 mm (3 Fr.)
506-3705	Ø 1.7 mm (5 Fr.)
506-3707	Ø 2.3 mm (7 Fr.)

### Scalpel Handles



Handle # 3	Length	Blades No.
508-063	4 <sup>3</sup> / <sub>4</sub> " (12 cm)	10 - 18

with cm graduation



Handle # 3	Length	Blades No.
508-0631	4 <sup>3</sup> / <sub>4</sub> " (12 cm)	10 - 18



Handle # 3L	Length	Blades No.
508-063L	8 <sup>3</sup> / <sub>4</sub> " (21 cm)	10 - 18



Handle # 4	Length	Blades No.
508-064	4 <sup>3</sup> / <sub>4</sub> " (12 cm)	20 - 25



Handle # 4L	Length	Blades No.
508-064L	8 <sup>3</sup> / <sub>4</sub> " (21 cm)	20 - 25



Handle # 7	Length	Blades No.
508-067	6 <sup>1</sup> / <sub>2</sub> " (16.5 cm)	10 - 18



Handle # 7K	Length	Blades No.
508-0671	5" (12.5 cm)	10 - 18



**SIEGEL Knife Handle, round**

Handle # 7K	Length	Blades No.
508-14015	6" (15.2 cm)	10 - 18

**BEAVER Handles**  
for micro scalpel blades



	Length
508-14310	4" (10 cm)
508-14312	5" (12.5 cm)
508-14315	6" (15 cm)

**Scalpel handles, round**



Straight	Angled	Blades / Length
548-41014	548-41114	10 - 18 / 5½" (14 cm)
548-41016	548-41116	20 - 25 / 6¼" (16 cm)

**Scalpel Handle, round**  
cm graduated



Handle # 3	Length	Blades No.
548-41214	5¾" (14.5 cm)	10 - 18



**JOSEPH Button End Knife**

	Length
546-37415	6" (15 cm)



**FREER Mucosa end Knife**

	Length
547-37415	6" (15 cm)



**JOSEPH Nasal Saws**

Length 7½" (19 cm)

546-6101	Straight
546-6102	Left bayonet
546-6103	Right bayonet

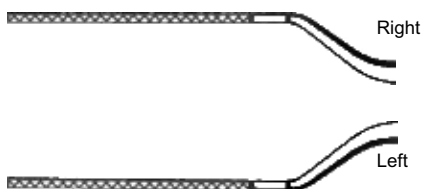



**WATSON Dermatome**

Length 12" (30 cm), fixed bar, complete with blade

<b>Right handed</b>	<b>Left handed</b>	<b>Spare blade</b>
<b>508-3500</b>	<b>508-3502</b>	<b>508-3501</b>



**HUMBY (BRAITHWAITE) Dermatome**

Length 12" (30 cm), with oscillating bar, complete with blade

	<b>Spare</b>
<b>508-3510</b>	<b>508-3501</b>

blade



**SILVER Dermatome**

Without blade, to be used with regular razor blades

	<b>Length</b>
<b>508-3600</b>	<b>7½" (19 cm)</b>



Spare razor blades for SILVER dermatome

	<b>Packing</b>
<b>508-3601</b>	<b>Pack of 10 Pcs</b>

**FOERSTER Capsulotomy Knife**

	<b>Length</b>
<b>572-1427</b>	<b>10¾" (27 cm)</b>

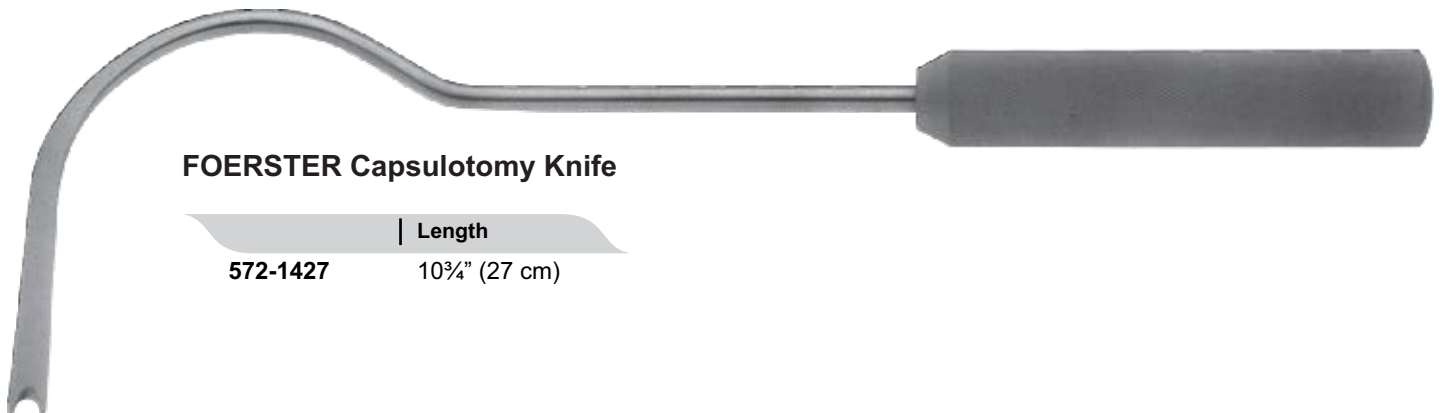

**Sponge Bowl**

Stainless Steel

	Size
<b>588-13002</b>	11.5 cm x 5 cm / 4.5" x 2"
<b>588-13003</b>	14.5 cm x 5 cm / 5.75" x 2.5"



**Solution Bowl**

Stainless Steel

	Size
<b>588-13013</b>	16.5 cm x 7.5 cm / 6.5" x 3"
<b>588-13023</b>	19 cm x 7.5 cm / 7.5" x 3"
<b>588-13025</b>	24.5 cm x 10 cm / 9.75" x 4"
<b>588-13027</b>	32.5 cm x 13.5 cm / 12.75" x 5.25"



**Emesis Kidney Basin**

	Size
<b>588-13915</b>	15 cm x 9 cm x 4.5 cm (6" x 3.5" x 1.75")
<b>588-13920</b>	20 cm x 9.5 cm x 4.5 cm (8" x 3.6" x 1.75")
<b>588-13925</b>	25.5 cm x 11.5 cm x 5 cm (10" x 4.5" x 2")



**Iodine Cup**

Stainless Steel

	Size
<b>588-14006</b>	3.5" x 2" (6 oz)
<b>588-14014</b>	(14 oz)



**Medicine Cup**

Graduated

<b>588-14202</b>	(2 oz)
------------------	--------





## Liposuction Cannulas

92 - 95, 98



## Micro Cannulas

96



## Handles

97



## Instruments for Lipoinjection

97



**Liposuction Cannulas**

Three holes, diagonal



Working Length	Diameter	Cannulas
----------------	----------	----------

8" (20 cm)	Ø 3 mm	<b>570-1203</b>
12" (30 cm)	Ø 3 mm	<b>570-1303</b>
12" (30 cm)	Ø 4 mm	<b>570-1304</b>
12" (30 cm)	Ø 5 mm	<b>570-1305</b>
12" (30 cm)	Ø 6 mm	<b>570-1306</b>

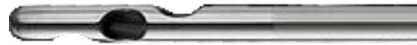

**Liposuction Cannulas**

One central hole on upper side / two lateral holes below



Working Length	Diameter	Cannulas
----------------	----------	----------

8" (20 cm)	Ø 3 mm	<b>570-2203</b>
12" (30 cm)	Ø 3 mm	<b>570-2303</b>
12" (30 cm)	Ø 4 mm	<b>570-2304</b>
12" (30 cm)	Ø 5 mm	<b>570-2305</b>
12" (30 cm)	Ø 6 mm	<b>570-2306</b>



**Liposuction Cannulas**

Two lateral holes on the upper side / one central hole below



Working Length	Diameter	Cannulas
----------------	----------	----------

8" (20 cm)	Ø 3 mm	<b>570-3203</b>
12" (30 cm)	Ø 3 mm	<b>570-3303</b>
12" (30 cm)	Ø 4 mm	<b>570-3304</b>
12" (30 cm)	Ø 5 mm	<b>570-3305</b>
12" (30 cm)	Ø 6 mm	<b>570-3306</b>



**Liposuction Cannulas**

One long central hole on the upper side / two lateral holes below



Working Length	Diameter	Cannulas
----------------	----------	----------

12" (30 cm)	Ø 4 mm	<b>570-4304</b>
12" (30 cm)	Ø 5 mm	<b>570-4305</b>



**TOLEDO Liposuction Cannulas**

Fork shaped, rounded tips, dissector between tips / one central hole

Working Length	Diameter	Cannulas
----------------	----------	----------

2" (5 cm)	Ø 2 mm	<b>570-5052</b>
2" (5 cm)	Ø 3 mm	<b>570-5053</b>
2" (5 cm)	Ø 4 mm	<b>570-5054</b>
6" (15 cm)	Ø 2 mm	<b>570-5152</b>
6" (15 cm)	Ø 3 mm	<b>570-5153</b>
10" (25 cm)	Ø 3 mm	<b>570-5253</b>
10" (25 cm)	Ø 4 mm	<b>570-5254</b>
12" (30 cm)	Ø 5 mm	<b>570-5305</b>



## Liposuction Cannulas

Top tip with hole / one lateral hole



Working Length	Diameter	Cannulas
8" (20 cm)	Ø 3 mm	570-6203
12" (30 cm)	Ø 3 mm	570-6303



## Liposuction Cannulas

Half cut tip 6 mm



Working Length	Diameter	Cannulas
12" (30 cm)	Ø 4 mm	570-7306
14" (35 cm)	Ø 4 mm	570-7356



## Liposuction Cannulas

10 holes, For infiltration



Working Length	Diameter	Cannulas
10" (25 cm)	Ø 2 mm	570-8252
10" (25 cm)	Ø 3 mm	570-8253



Ø 1 mm each

## MERCEDES Liposuction Cannulas

Three lateral holes

Working Length	Diameter	Cannulas
6" (15 cm)	Ø 2 mm	570-7512
6" (15 cm)	Ø 3 mm	570-7513
10" (25 cm)	Ø 3 mm	570-7523
6" (15 cm)	Ø 4 mm	570-7514
10" (25 cm)	Ø 4 mm	570-7524
10" (25 cm)	Ø 5 mm	570-7525
12" (30 cm)	Ø 5 mm	570-7535



## KOTZUR Liposuction Cannulas

9 holes



Working Length	Diameter	Cannulas
12" (30 cm)	Ø 3 mm	570-7733



**Liposuction Cannulas**

One central hole, for fine facial contourings



Handle Conn.	Luer-Lock Conn.	Diameter	Working Length
570-6601	573-6601	Ø 1.7 mm	2" (5 cm)
570-6602	573-6602	Ø 2.0 mm	2" (5 cm)
570-6603	573-6603	Ø 3.0 mm	2" (5 cm)
570-6612	573-6612	Ø 2.0 mm	4" (10 cm)
570-6611	573-6611	Ø 1.7 mm	6" (15 cm)
570-6622	573-6622	Ø 2.0 mm	6" (15 cm)
570-6613	573-6613	Ø 3.0 mm	6" (15 cm)

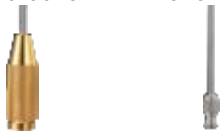

**Liposuction Cannulas**

8 holes, for fine facial contourings



Handle Conn.	Luer-Lock Conn.	Diameter	Dia. Holes	Working Length
570-6715		Ø 1.7 mm	Ø 0.5 mm	4" (10 cm)
570-6711		Ø 2.0 mm	Ø 1.0 mm	4" (10 cm)
570-6721	573-6721	Ø 2.0 mm	Ø 1.0 mm	6" (15 cm)



**ENTNER Liposuction Cannulas**

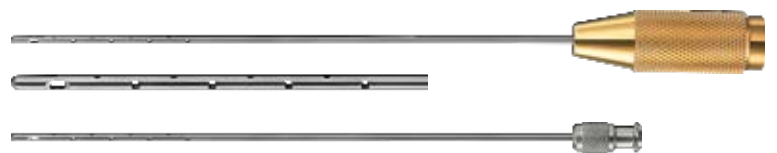

Handle Conn.	Luer-Lock Conn.	Diameter	Dia. Holes	Holes	Working Length
570-6802	573-6802	Ø 2.0 mm	Ø 1.0 mm	18	6" (15 cm)
570-6812	573-6812	Ø 2.5 mm	Ø 1.2 mm	18	6" (15 cm)
570-6803	573-6803	Ø 3.0 mm	Ø 1.5 mm	18	6" (15 cm)
570-6822	573-6822	Ø 2.5 mm	Ø 1.2 mm	22	8" (20 cm)
570-6823	573-6823	Ø 3.0 mm	Ø 1.5 mm	22	8" (20 cm)
570-6824	573-6824	Ø 4.0 mm	Ø 2.0 mm	22	8" (20 cm)
570-6815	573-6815	Ø 2.5 mm	Ø 1.2 mm	26	10" (25 cm)
570-6833	573-6833	Ø 3.0 mm	Ø 1.5 mm	30	12" (30 cm)
570-6834	573-6834	Ø 4.0 mm	Ø 2.0 mm	30	12" (30 cm)



**ENTNER Liposuction Cannulas**

22 holes

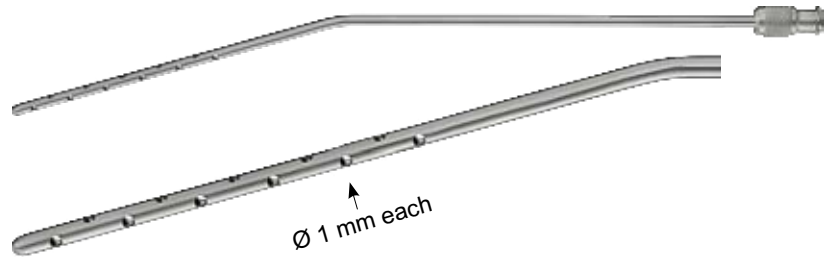

Handle Conn.	Luer-Lock Conn.	Diameter	Working Length
570-7823	573-7823	Ø 3.0 mm	8" (20 cm)



**ENTNER Liposuction Cannulas**

Bayonet shaped



Handle Conn.	Luer-Lock Conn.	Diameter	Dia. Holes	Holes	Working Length
570-7923	573-7923	Ø 3.0 mm	Ø 1.5 mm	22	8" (20 cm)
570-7924	573-7924	Ø 4.0 mm	Ø 2.0 mm	22	8" (20 cm)
570-7933	573-7933	Ø 3.0 mm	Ø 1.5 mm	30	12" (30 cm)
570-7934	573-7934	Ø 4.0 mm	Ø 2.0 mm	30	12" (30 cm)





**Micro Cannulas**

Working Length 4" (10 cm)



	Diameter	Dia. Holes	Holes	Suction Range
<b>573-9105</b>	Ø 1.5 mm		1	1 mm
<b>573-9115</b>	Ø 1.5 mm	Ø 0.7 mm	10	15 mm
<b>573-9112</b>	Ø 2.0 mm	Ø 0.9 mm	10	15 mm

**Micro Cannulas**

Working Length 6" (15 cm)



	Diameter	Dia. Holes	Holes	Suction Range
<b>573-9212</b>	Ø 2.0 mm	Ø 0.9 mm	14	20 mm
<b>573-9215</b>	Ø 2.5 mm	Ø 0.9 mm	14	20 mm

**Micro Cannulas**

Working Length 8" (20 cm)



	Diameter	Dia. Holes	Holes	Suction Range
<b>573-9312</b>	Ø 2.5 mm	Ø 1.2 mm	22	30 mm
<b>573-9313</b>	Ø 3.0 mm	Ø 1.5 mm	22	30 mm

**Micro Cannulas**

Working Length 10" (25 cm)



	Diameter	Dia. Holes	Holes	Suction Range
<b>573-9412</b>	Ø 2.5 mm	Ø 1.2 mm	22	30 mm
<b>573-9414</b>	Ø 4.0 mm	Ø 2.0 mm	22	45 mm

**Micro Cannulas**

Working Length 12" (30 cm)



	Diameter	Dia. Holes	Holes	Suction Range
<b>573-9513</b>	Ø 3.0 mm	Ø 1.5 mm	22	30 mm

**Micro Cannulas**

Working Length 13¾" (35 cm)



	Diameter	Dia. Holes	Holes	Suction Range
<b>573-9624</b>	Ø 4.0 mm	Ø 2.0 mm	22	45 mm

**Micro Cannulas**

Working Length 16" (40 cm)



	Diameter	Dia. Holes	Holes	Suction Range
<b>573-9725</b>	Ø 5.0 mm	Ø 2.5 mm	22	55 mm

# Cannulas Handles

Handles for Cannulas

# SURGIXA

## Handle for Cannulas

with connection thread for cannulas hose connection

Length	Diameter	Handle
5¼" (13 cm)	Ø 13 mm	570-9013

Length	Diameter	Handle
5¼" (13 cm)	Ø 13 mm	570-9113

## Handle for Cannulas

with connection thread for cannulas hose connection

Length	Diameter	Handle
5½" (14 cm)	Ø 13 mm	570-8013

Length	Diameter	Handle
5½" (14 cm)	Ø 13 mm	570-8113



## Suction Adapter for Lure lock

Length
3" (7.5 cm)

570-0010



## Syringe Stand for Lure Lock

For safe storage of syringes

Diameter
Ø 40 mm

570-0040



## Stop for Syringes

Lock maintains vacuum in the syringe

ml
20
30
50 / 60

570-0012  
570-0013  
570-0015



## Adapter Luer-Lock

Length
5" (2 cm)

570-0050



# Liposuction Cannulas

With Thumb Plate

# SURGIXA

## GASPAROTTI Liposuction Cannulas

One central hole, with attached Handle



Working Length	Diameter	Straight
6" (15 cm)	Ø 3 mm	571-1153
6" (15 cm)	Ø 6 mm	571-1156
10" (25 cm)	Ø 4 mm	571-1254
10" (25 cm)	Ø 6 mm	571-1256
12" (30 cm)	Ø 9 mm	571-1309

## GASPAROTTI Liposuction Cannulas

Two central hole, with attached Handle



Working Length	Diameter	Straight
6" (15 cm)	Ø 4 mm	571-2154
10" (25 cm)	Ø 6 mm	571-2254
12" (30 cm)	Ø 6 mm	571-2306

## GASPAROTTI Liposuction Cannulas

One central hole, with attached Handle

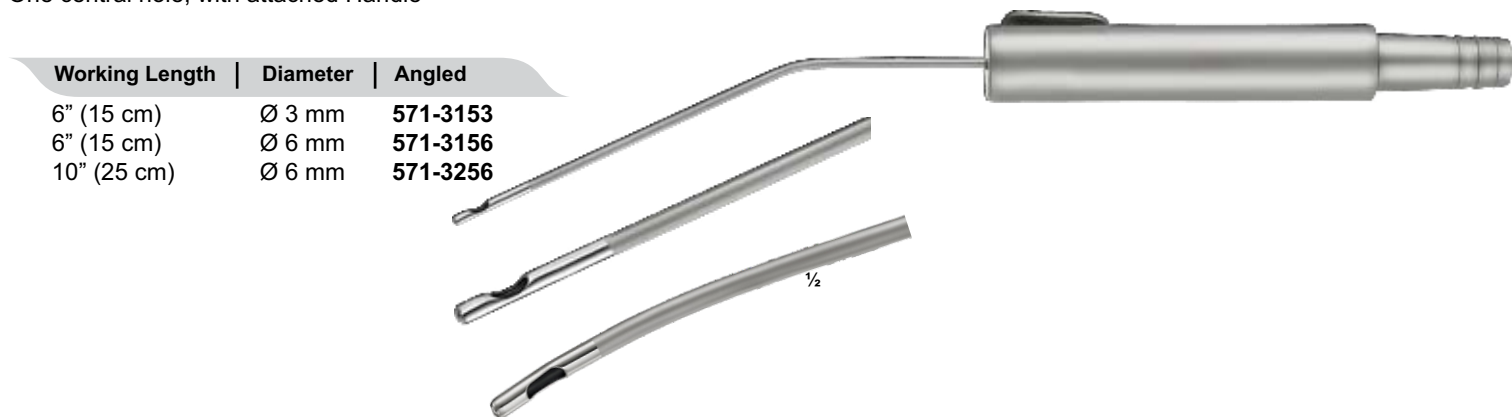

Working Length	Diameter	Angled
6" (15 cm)	Ø 3 mm	571-3153
6" (15 cm)	Ø 6 mm	571-3156
10" (25 cm)	Ø 6 mm	571-3256

## LED Headlight

100 - 101



## Light Guide Cables

102



- Comfortable lightweight headlight.
- Cool bright and precise illumination.
- Shadow-free light allows clear visualization.
- Completely portable; allowing the user freedom of movement.
- Energy efficient.
- Cool beam is safe to touch.
- No UV rays.
- Long battery backup

## LED Headlight Portable with rechargeable battery pack

LED life	<b>50,000 hours</b>
Light Intensity	<b>&gt;20000 LUX</b> (at a spot size of 35 mm)
Color temperature	<b>5000 K - 5800 K</b> (daylight)
Adjustable Light Focus	<b>20 - 45 mm</b> (at 10 cm distance) <b>35 - 100 mm</b> (at 20 cm distance)

502-2020



## Battery Pack - Rechargeable

502-2028	<b>Li-Ion Technology Protected</b>
Rechargeable Voltage	<b>4.2 V</b>
Charging time	<b>~ 4.5 hours</b>
Battery life	<b>~ 500 charges</b>
Operating time	<b>~ 8 hours</b>
Battery Status	<b>10 segment 3 LED display colors</b>





**Charger for Headlight**

with pack of four plugs (US, UK, AU, EU)

502-2029

Input AC	100 - 240 V, 50/60 Hz
Output	4.2 V / 1300mA



2 pin flat  
US

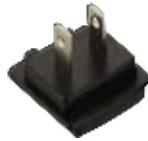

3 pin flat  
UK



2 pin flat  
AU



2 pin round  
EU



**LED**  
Technology

- Flexible grey colored silicone-rubber sheathing
- Full length stainless steel sleaving around fiber bundle
- Stainless steel ends and adaptor
- Autoclavable / Steam Sterilizable

Other lengths, colors, fiber diameters and adaptors are available on demand.

## Fiberoptic Light Guide Cables

Including Storz adaptor for light source instruments sides

Light Guide	Diameter	Length
<b>591-3560</b>	Ø 3.5 mm	6 feet (183 cm)
<b>591-3575</b>	Ø 3.5 mm	7.5 feet (229 cm)
<b>591-5060</b>	Ø 5.0 mm	6 feet (183 cm)
<b>591-5075</b>	Ø 5.0 mm	7.5 feet (229 cm)
<b>591-5010</b>	Ø 5.0 mm	10 feet (305 cm)

### Without adaptors

Light Guide	Diameter	Length
<b>591-35601</b>	Ø 3.5 mm	6 feet (183 cm)
<b>591-35751</b>	Ø 3.5 mm	7.5 feet (229 cm)
<b>591-50601</b>	Ø 5.0 mm	6 feet (183 cm)
<b>591-50751</b>	Ø 5.0 mm	7.5 feet (229 cm)



## Light Source Side Adapter

Adapters	Manufacturer
<b>591-910</b>	Olympus
<b>591-911</b>	Storz
<b>591-912</b>	ACMI/British Standard
<b>591-913</b>	Wolf



**591-910**



**591-911**



**591-912**



**591-913**



**591-920**



**591-922**



**591-921**

## Instrument/Endoscope Side Adapter

Adapters	Manufacturer
<b>591-920</b>	Wolf
<b>591-921</b>	ACMI/British Standard
<b>591-922</b>	Storz

New Arrivals

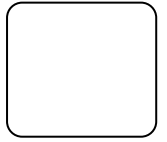

103 - 108

### TEBBETTS Style Retractors

with serrated tip, Non conductive insulated blade

With Light Guide	With Light Guide & Suction	Blades
572-10107	572-10108	16 mm x 8 cm
572-10127	572-10128	16 mm x 18 cm
572-10207	572-10208	24 mm x 9 cm
572-10227	572-10228	24 mm x 10 cm
572-10247	572-10248	25 mm x 10 cm
572-10267	572-10268	25 mm x 12 cm
572-10287	572-10288	25 mm x 15 cm
572-10197	572-10198	25 mm x 18 cm
572-10187	572-10188	25 mm x 20 cm
572-10307	572-10308	30 mm x 9 cm
572-10327	572-10328	30 mm x 12 cm
572-10347	572-10348	30 mm x 15 cm
572-10367	572-10368	30 mm x 19 cm
572-10407	572-10408	36 mm x 16 cm
572-10507	572-10508	36 mm x 19 cm

(Not illustrated)

### FERRIERA Style Retractors

with smooth tip, Non conductive insulated blade

With Light Guide	With Light Guide & Suction	Blades
572-10567	572-10568	14 mm x 7 cm
572-10587	572-10588	14 mm x 9 cm
572-10607	572-10608	16 mm x 8 cm
572-10627	572-10628	16 mm x 15 cm
572-10647	572-10648	23 mm x 10 cm
572-10667	572-10668	23 mm x 15 cm
572-10687	572-10688	23 mm x 18 cm
572-10787	572-10788	24 mm x 9 cm
572-10797	572-10798	25 mm x 8 cm
572-10827	572-10828	25 mm x 10 cm
572-10847	572-10848	25 mm x 12 cm
572-10867	572-10868	25 mm x 15 cm
572-10807	572-10808	25 mm x 19 cm
572-10697	572-10698	30 mm x 9 cm
572-10707	572-10708	30 mm x 12 cm
572-10727	572-10728	30 mm x 15 cm
572-10747	572-10748	30 mm x 18 cm
572-10767	572-10768	30 mm x 19 cm



**Face-Lift Retractor**

With reverse blades serrated tip

With Light Guide & Suction	Blades
----------------------------	--------

572-1092	80 x 16 mm
----------	------------

(Not illustrated)

With Endoscopic Channel & Stopcock, to hold 4 mm telescopes

	Blades
--	--------

572-1133	23 mm x 15 cm
572-1134	25 mm x 18 cm



With Endoscopic Channel & Stopcock, to hold 10 mm telescopes

	Blades
--	--------

572-1135	23 mm x 15 cm
572-1136	25 mm x 18 cm



## Mammoplasty Retractor

Narrow blade

With Light Guide	Blade
572-1094	25 mm x 17 mm

(Not illustrated)



## MARX Breast Retractors

Total Length 10 $\frac{3}{4}$ " (27 cm)

	Blades Size
572-1425	125 x 30 mm
572-1440	140 x 30 mm



## Breast Elevator

	Length
572-1868	11" (29 cm)





**Umbilical Markers**

Length 14" (35 cm)

	Size
572-1865	35 mm

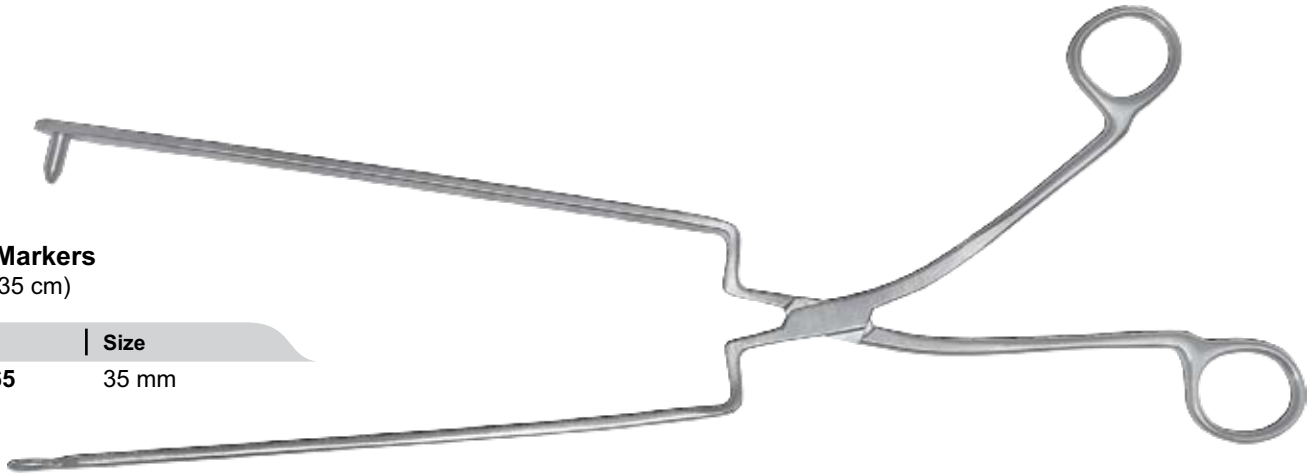

**Umbilical Navel Marker**

		Length
572-1863	Oval Tip	14" (35 cm)
572-1864	Detacable	13" (32.5 cm)

(Not illustrated)

**D'ASSUMPCAO Abdominal Flap Marker**

Length 12" (30.5 cm), without ratchet

	Width
572-1861	9 mm



**Midface Dissector**

Scissors style ring handles

Curved	Blades	Length
572-1610	10 x 15 mm	9" (23 cm)

# Retractors

Hooks, Breast Elevators

# SURGIXA

## ASTON Submental Fiberoptic Retractor

Tapered blades, Length 6" (15.5 cm)

With Light Guide	With Light Guide & Suction	Blades
572-61029	572-62029	18 mm x 6 cm



## COTTLE Nasal Retractor

Length 6" (15 cm)

With Light Guide	Blades
572-115015	50 mm



## GERBAULT Suction Retractor

With Suction	Length
572-0191	7½" (19 cm)



## BERENS Mastectomy Skin Flap Retractor

Sharp

Length	Blade Size
572-1380	8" (20 cm) 85 mm



## FREEMAN Double Skin Hook

Sharp

Length	
572-1370	4" (10 cm)



# Reference Information

**Cleaning & Sterilization Instructions**

104 - 105



**Returned Goods Policy & Warranty**

106

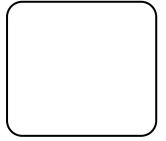

## Description

Surgical and dental instruments are designed to perform specific functions such as cutting, grasping, clamping, dissecting, probing, retracting, draining, aspirating, suturing, or ligating. Surgical instruments may also be used to facilitate the insertion of surgical implants.

## Contraindication

Instruments should not be used for anything other than their intended use.

## Warning

Devices shall be used in accordance with these instructions for use. Read all sections of this insert prior to use. Improper use of this device may cause serious injury. In addition, improper care and maintenance of the device may render the device non-sterile prior to patient use and cause a serious injury to the patient or health care provider.

## Caution

- Carnegie Surgical instruments are supplied non-sterile, unless otherwise noted and must be cleaned, lubricated (if required) and sterilized prior to use according to hospital protocol and procedures outlined in this document.
- Inappropriate use of instruments may result in patient injury, damaged or broken instruments.
- Proper cleaning, handling, sterilization and standard routine maintenance (such as sharpening, lubrication if applicable) will ensure that the instruments perform as intended and will extend their useful life.
- Delicate surgical/dental instruments require special handling to prevent damaging the tips. Use caution during cleaning and sterilization.
- Do not expose instruments to phenols or iodophors.
- Do not use dry heat sterilization for aluminum or plastic made, black coated or ebonized instruments.
- Do not apply excessive stress or strain at joints; misuse will result in mis alignment or cracks at the box locks or jaws.
- Rongeurs and bone cutting forceps should only be used to cut bone, never wire or pin. Do not twist or apply excessive stress during use.
- Wear appropriate protective gloves, eyewear and clothing when handling biologically contaminated instruments.
- Instruments manufactured from different metals or with special coating, should be processed separately to avoid electrolytic action between the different metals.
- Before use, inspect the instruments for possible damage, wear or non-functioning parts. Carefully inspect the critical, inaccessible areas, joints and all movable parts.
- Damaged or defective instruments should not be used or processed.

## Care And Handling

### 1. Precleaning:

- Keep instruments moist and do not allow blood and/or bodily fluids to dry on the instruments.
- Remove gross contaminants with steady stream of lukewarm/cool water (below 110°F/43°C). Rinse each instrument thoroughly. Do not use saline or chlorinated solutions.
- Open jaws of hinged instruments for cleaning. Give special attention to joints and serrations. Instruments having more than one part or piece must be disassembled (if possible) to expose all surfaces to the cleaning process. Retain all parts to facilitate reassembly.
- Separate sharp and delicate surgical instruments. Avoid processing instruments of different metallic composition together.
- Keep ebonized instruments separate from other stainless steel instruments to avoid scratches to and removal of the ebonized coating.

2. **Rinse:** Rinse instruments thoroughly under warm distilled or demineralized water.

## 3. Cleaning:

### Cleaning Precautions

- If appropriate, disassemble surgical instruments prior to cleaning and sterilization.
- Do not soak instruments in hot water, alcohol, disinfectants or antiseptics to avoid coagulation of mucus, blood or other body fluids. Do not exceed two hours soaking in any solution.
- Do not use steel wool, wire brushes, pipe cleaners or abrasive detergents to remove soil as these will damage the instrument and lead to corrosion.
- Microsurgical, plated and delicate instruments should be cleaned manually and should not be processed in an ultrasonic cleaner. Carefully protect the tips of delicate microsurgical instruments throughout the entire cleaning and sterilization process.
- To preserve the surface coating of ebonized instruments, keep ebonized instruments separate from other instruments and avoid mechanical cleaning and abrasive cleaners as these processes can scratch the surface and remove the surface coating.
- Color anodized aluminum instruments may lose their color through the use of conventional, mechanical treatment processes.

- A. **Manual Cleaning:** To prevent formation of biofilm, cleaning should occur as soon as possible after instrumentation is used.
  - Choose a cleaning solution appropriate for surgical/dental instruments and follow manufacturer's instructions for use.
  - The use of neutral pH detergents is recommended to avoid corrosion, pitting and breakage.
  - Using a small, clean hand-held brush, remove soil from all surfaces of instrument while fully immersed in solution

### B. Ultrasonic And Mechanical Cleaning

- For ultrasonic cleaning, follow manufacturer's specifications for water level, concentration levels of cleaning agent and temperature.
- Use an ultrasonic cleaner to remove soil from hard to reach surfaces such as grooves, crevices and moving parts after gross soil has been removed.
- Open or disassemble instruments as appropriate.
- When using mechanical washer, make sure all instruments stay properly in place and do not touch or overlap each other.
- Do not allow ebonized instruments to come in contact with each other or other instruments.
- Always follow the manufacturer's specifications for automatic washer-sterilizers and use a free-rinsing, low-sudsing detergent with a neutral pH (6.0 - 8.5). Due to variations in water quality, the type of detergent and its concentration may require adjustment for optimal cleaning.

4. **Rinse And Dry:** Rinse all instruments thoroughly with distilled, pyrogen-free water to remove all traces of debris and cleansing agents. Make sure all internal lumens and ratchets are thoroughly rinsed. Instruments must be thoroughly dried and all residual moisture must be removed before they are stored. Use a soft, absorbent towel/cloth to dry external surfaces. Compressed air may be used to aid the drying process.

5. **Lubricate:** The use of a water soluble instrument lubricant that is compatible with the method of sterilization to be used is recommended before instruments are sterilized.

- After thoroughly cleaning the instruments, proper application of lubricants to all joints and movable mating surfaces will keep them moving freely and aid in protecting surface from mineral deposits.
- Proper lubrication is required for all instruments, regardless of surface coatings.
- Note that ultrasonic cleaners remove all lubrication; therefore, this maintenance procedure should be done routinely after ultrasonic cleaning and before sterilization.
- If following the lubricating procedure, do not rinse after this step.

## 6. Sterilization:

All devices must be processed in the completely open position (i.e. flushports, jaws, etc.) to allow sterilant contact of all surfaces.

All devices with concave surfaces shall be configured so that water pooling does not occur.

Sterilization Method	Temperature	Exposure Time	Dry Time
<b>High Vacuum Steam (Pre-vacuum)</b>			
Wrapped	270°F (132°C)	3 minutes minimum	N/A

<b>High Vacuum Steam (Pre-vacuum)</b>			
Unwrapped in containers	270°F (132°C)	4 minutes minimum	20 minutes
Perforated stacked/unstacked			
Solid unstacked			
<b>Gravity Steam</b>			
Unwrapped in containers	250°F (121°C)	45 minutes	20 minutes
Perforated unstacked			
<b>Gravity Steam</b>			
Wrapped in cassettes	250°F (121°C)	30 minutes	20 minutes
<b>Ethylene Oxide (EtO)</b>			
Unwrapped in containers	131°F (55°C)	60 minutes (minimum) Concentration: 725 mg/l Humidity: 70% Aeration time: 8 hours minimum	
Perforated unstacked			
Solid unstacked			

## 7. Storage

After sterilization, devices must remain in sterilization packaging and be stored in a clean, dry environment.

## Returned Goods Policy

1. Goods will be accepted for return for the following reasons and must be accompanied by a RGA.
  - A. If shipment was made without Customer's authorization;
  - B. If incorrect items were shipped;
  - C. If defective items were shipped ;
  - D. If defective goods are covered by the standard warranty;
  - E. If the goods were sent on evaluation basis.
2. To return goods, contact a Customer Service Representative by telephone for an RGA (Returned Goods Authorization) number. The RGA # must also be clearly indicated on the outside of the returned package. Please have the following information:
  - A. Reason you wish to return the goods;
  - B. Quantity, description, product number;
  - C. Date of Receipt of Order;
  - D. Customer's Purchase Order and the Carnegie Surgical invoice number;
  - E. All instruments that have been used must be cleaned and sterilized prior to shipment.
3. Shipment must be returned prepaid by Customer. Freight collect shipments will not be accepted.
4. If Customer intends to return equipment ordered in error, the following restocking charges and terms will apply:
  - A. 25% within 90 days from date of shipment;
  - B. Goods must be returned unused, in the original carton, and in marketable condition;
  - C. Refurbishing and replacement charges will be added to the restocking charges for damaged or missing items;
  - D. No return after 90 days;
  - E. No refund on sterile, single-use disposable products.
  - F. No refund will be made on customized instruments.

**Send all Returns to:**  
 Carnegie Surgical LLC  
 118 Dey Street,  
 Hightstown NJ 08520, USA

## Warranty

### Carnegie Surgical

two (2) years from the original date of purchase. Carnegie Surgical single patient use products are warranted for 90 days against defects in workmanship or materials that are discovered prior to initial use or expiration. If Carnegie Surgical instruments should fail as the result of a defect in materials or workmanship, Carnegie Surgical is committed to take steps it believes are necessary to rectify the problem. These steps may include, but are not limited to, repair, replacement or supplying an alternative instrument. This warranty does not cover general maintenance such as cleaning and sharpening services required as a result of normal use. It does not include damage that is caused by misuse, improper care, the use of improper chemicals or cleaning methods, negligence, modification or unauthorized service by non-Carnegie Surgical personnel, or normal wear. Damage to insulating coatings on electro-surgical instruments is excluded from the terms of this warranty.

The sole remedy under this warranty shall be repair or replacement as provided above at the sole discretion of Carnegie Surgical Instruments. In no event will Carnegie Surgical be liable for any damages arising out of loss of use, or any other incidental or consequential damages. The foregoing limited warranty is in lieu of any other warranty with respect to Carnegie Surgical products. Carnegie Surgical grants no other warranty, express or implied

stainless steel instruments are warranted for a period of



# Alphabetical Index

Alphabetical Index

**A - Z**

113 - 116

# A



Description	Page	Description	Page	Description	Page
<b>I</b>					
Iconoclast (Breast Spreaders) . . . . .	18	LUCAE Bone Mallet . . . . .	38	OBWEGESSER Periosteal Elevators . . . . .	34
Instrument/Endoscope Side Adapter . . . . .	102	LUCAE Ear Polypus Forceps . . . . .	69	OEHLER Dressing Forceps . . . . .	68
Iodine Cup . . . . .	90	<b>M</b>			
IRIS Ribbon Scissors . . . . .	59	MALINIAC Nasal Retractors . . . . .	5	OLSEN HEGAR Needle Holders . . . . .	82
IRIS Scissors . . . . .	59	Mallet . . . . .	37	Operating Scissors . . . . .	54
<b>J</b>					
JACOBS Breast Dissector . . . . .	16	Mallet (Nylon / Steel) . . . . .	37	Orbital Rim Dissector . . . . .	22
JAEGER Lid Plate / Suturing Specula . . . . .	11	Mallet (Nylon) . . . . .	38	<b>P</b>	
JAMESON Calipers . . . . .	30	MALTZ Nasal Rasps . . . . .	44	PAR Forceps . . . . .	67
JANSEN-GRUENWALD Nasal		Mammoplasty Retractor . . . . .	106	PAR Needle Holders . . . . .	81
Polypus Forceps . . . . .	69	MARTEN Flap Markers . . . . .	28	PAR Scissors . . . . .	62
JANSEN-MIDDLETON Nasal Cutting Forceps . . . . .	43	MARTINEZ KILNER Retractors . . . . .	10	PARKES Gouge . . . . .	35
Jeweller's Forceps . . . . .	71	MARTINI Bone Spoon . . . . .	32	PARKES Lateral Osteotome . . . . .	35
JONES Towel Clamps . . . . .	77	MARX Breast Retractors . . . . .	106	PARKES Nasal Rasps . . . . .	44
JOSEPH Button End Knife . . . . .	88	MAXWELL FLAP Retractors . . . . .	9	Periosteal Elevators . . . . .	22
JOSEPH Nasal Rasps . . . . .	45	MAYO Dissecting Scissors . . . . .	54	Periosteal Spreaders . . . . .	22
JOSEPH Nasal Saws . . . . .	88	MAYO HEGAR Needle Holders . . . . .	82	PITANGUY Facial Demarcators . . . . .	28
JOSEPH Nasal Scissors . . . . .	58	MAYO-NOBLE Dissecting Scissors . . . . .	54	PITANGUY Flap Grasping Forceps . . . . .	28
JOSEPH Periosteal Elevator . . . . .	34	McCOLLOUGH Elevator . . . . .	33	POTTS-SMITH Dressing Forceps . . . . .	68
JOSEPH Skin Hooks . . . . .	12	McCOLLUM-DINGMAN Breast Dissectors . . . . .	16	Projectometer . . . . .	27
JULIAN MOSQUITO Forceps . . . . .	74	McCOLLUM-DINGMAN Submammary		<b>R</b>	
<b>K</b>					
KASDEN Retractor . . . . .	11	Dissector . . . . .	18	RAGNELL Retractors . . . . .	10
KAYE Blepharoplasty Scissors . . . . .	60	McCOY Micro Dermal Hook . . . . .	12	RAGNELL-DAVIS Retractor . . . . .	10
KAYE Face-Lift Scissors . . . . .	56	McINDOE Tissue Forceps . . . . .	69	RALK Splinter Forceps . . . . .	72
KAYE-FREEMAN Face-Lift Scissors . . . . .	56	McKENTY Elevators . . . . .	34	RANKIN-CRILE Hemostatic Forceps . . . . .	75
KELLY Hemostatic Forceps . . . . .	74	McKISSOCK (COLLYER) Caliper . . . . .	29	REES Face-Lift Scissors . . . . .	57
KELLY Scissors . . . . .	54	McKISSOCK Keyhole Markers/Calipers . . . . .	27	REES Osteotome . . . . .	35
KILLIAN Nasal Speculas . . . . .	40	McPHERSON Suture Forceps . . . . .	70	REYNOLDS Tenotomy & Facelift Scissors . . . . .	59
KILNER Dissecting Scissors . . . . .	54	MEAD Mallet . . . . .	37	REYNOLDS Transauxillary Breast Dissectors . . . . .	17
KILNER Skin Hook . . . . .	13	Medicine Cup . . . . .	90	RIBBON Retractors . . . . .	7
KLEINERT KUTZ Hooklets . . . . .	12	MERCEDES Liposuction Cannulas . . . . .	93	RICHARDSON-EASTMAN Retractors . . . . .	7
KLEINERT-KUTZ Bone Cutting Forceps . . . . .	49	Metal Rulers . . . . .	29	RISTOW Rhinoplastic Chisels . . . . .	35
Knife Handle, for plastic surgery . . . . .	24	METZENBAUM Dissecting Scissors . . . . .	55	ROCHESTER-PEAN Hemostatic Forceps . . . . .	75
KNIGHT Nasal Scissors . . . . .	58	METZENBAUM Fino Dissecting Scissors . . . . .	55	ROLLET Rake Retractor . . . . .	13
KNOWLES Bandage Scissors . . . . .	63	Micro Cannulas . . . . .	96	ROWE Zygomatic Bone Elevators . . . . .	33
KOCHER (OCHSNER) Hemostatic Forceps . . . . .	75	Micro Dressing and Suture Forceps . . . . .	71	RUBIN Septal Morselizers . . . . .	43
KOTZUR Liposuction Cannulas . . . . .	93	Micro Needle Holders . . . . .	84	RUBIN Type Osteotomes . . . . .	36
<b>L</b>					
LAHEY Vulsellum Forceps . . . . .	77	Micro Scissors, with round handle . . . . .	64	RUSKIN-LISTON Bone Cutting Forceps . . . . .	49
LAMBOTTE Osteotomes . . . . .	36	Micro Vascular Needle Holders . . . . .	83	<b>S</b>	
Lead Hand . . . . .	7	Micro Vessel Dilating Forceps . . . . .	71	Scalp Elevators . . . . .	20-21
LED Headlight Portable . . . . .	100	Midface Dissector . . . . .	107	Scalpel Handles . . . . .	87-88
LEMMON Needle Holders . . . . .	83	Midface Facial Dissectors . . . . .	23	SCHAMBERG Comedon Extractors . . . . .	32
LEMPERT Bone Rongeurs . . . . .	48	MILLARD (ADSON) Hooks Forceps . . . . .	10	SEALY Scissors . . . . .	60
LEWIS Nasal Rasps . . . . .	44	MILLER Rake Retractor . . . . .	13	SEMKEN Dressing Forceps . . . . .	68
LEXER-BABY Dissecting Scissors . . . . .	55	MILLER-COLBOURNE Bone Files . . . . .	46	SENN Retractors . . . . .	11
Light Source Side Adapter . . . . .	102	MINI-FRIEDMAN Bone Rongeurs . . . . .	48	SHEA Fine Scissors . . . . .	60
Liposuction Cannulas . . . . .	92, 93-94	Mirco Suture Tying Forceps . . . . .	71	SHEEHAN Osteotomes . . . . .	36
LISTER Bandage Scissors . . . . .	63	MITCHELLS Trimmer/Elevator . . . . .	33	SHEEN Grid . . . . .	29
LISTON Bone Cutting Forceps . . . . .	49	MIXTER Hemostatic Forceps . . . . .	76	SHEEN PARKES Nasal Retractor . . . . .	11
LITTAUER Cilia Forceps . . . . .	72	Multi Approach Retractor . . . . .	4	SHEEN Radix Chisels . . . . .	36
LITTAUER Stitch Scissors . . . . .	62	<b>N</b>			
LITTLER Stitch Scissors . . . . .	62	Needle Nose Pliers . . . . .	52	SHEEN Retractor . . . . .	11
LOCKWOOD Abdominal Demarcator . . . . .	29	NEIVERT (OFFSET) Needle Holder . . . . .	81	SHEEN-KILLIAN Septum/Nasal Forceps . . . . .	41
LOCKWOOD Underminer Dissector . . . . .	17	NEIVERT Rhinoplastic Chisels . . . . .	35	SIEGEL Knife Handle, round . . . . .	88
LOGAN Bow Lip traction Retractors . . . . .	10	Nerve Cutting Knife . . . . .	24	SILVER Dermatome . . . . .	89
LORNA-EDNA Towel Clamp . . . . .	77	Nerve Dissector . . . . .	24	SILVER Rhinoplastic Chisels . . . . .	34
<b>O</b>					
		Nerve Hooks . . . . .	24	Solution Bowl . . . . .	90
		Nerve Protectors . . . . .	24	Spatulated Dissector . . . . .	16
		<b>P</b>			
		O'BRIEN Stitch Scissors . . . . .	63	SPENCER Stitch Scissors . . . . .	63
		O'CONNOR (IRIS) Hooks . . . . .	12	Splinter Forceps . . . . .	72
		<b>R</b>			
				Sponge Bowl . . . . .	90
				STEVENS Tenotomy Scissors . . . . .	59
				Stop for Syringes . . . . .	97

**Description Page**

STRABISMUS Scissors .....60  
 Suction Adapter for Lure lock .....97  
 SWEDISH Needle Holder .....82  
 Syringe Stand for Lure Lock .....97

**T**

TAKAHASHI (WATSON-WILLIAMS) Nasal  
 Cutting Forceps .....41  
 TAYLOR Forceps .....68  
 TEBBETTS Style Retractors .....2  
 TEBBETTS Style Retractors Insulated .....104  
 Temporal T- Dissector .....22  
 Thimble Hooks .....10  
 THORPE (MARCHAC) Calipers .....30  
 TOLEDO Liposuction Cannulas .....92  
 TOLSDORF Cartilage Crusher .....43  
 Transoral Dissectors .....23  
 Transumbilical Breast Augmentation .....18  
 Trepsat Facial Flap Dissector Scissors .....18  
 Trocar Breast Tubes .....19  
 TROELTSCH (WILDE) Ear Polypus Forceps .....69  
 TYRELL Skin Hook .....12

**U**

Umbilical Markers .....107  
 Umbilical Navel Marker .....107  
 Universal Adapter .....108  
 Universal Flat Nose Pliers .....52  
 Universal Wire Scissors .....62  
 UNNA Comedon Extractors .....32  
 US ARMY (PARKER LANGENBECK) Retractors . .7  
 USA MODEL Tubing Clamps .....78  
 Universal Bandage Scissors .....63

**V**

VANNAS Micro Scissors .....64  
 VIENNA Nasal Speculas .....40  
 V-Shaped Breast Dissector .....19  
 WALDEN Breast Marker .....27  
 WALSHAM Septum Straightening Forceps .....41  
 WALTER-CARMALT Splinter Forceps .....72  
 WATSON Dermatome .....89  
 WEBSTER (BABY) Needle Holders .....80  
 WEBSTER Needle Holders .....80  
 WEIL-BLAKESLEY (WILDE) Nasal  
 Cutting Forceps .....41

**W**

WEITLANER BABY Retractors .....14  
 WEITLANER Retractors .....14  
 WESTCOTT Micro Scissors .....64  
 WESTCOTT Stitch Scissors .....64  
 WIEDER Tongue Depressors .....4  
 WILKINSON Face-Lift Scissors .....57  
 WILLIGER Bone Spoon .....32  
 WILLIGER Elevator .....33  
 WILMER Conjunctival and Utility Scissors . .61  
 Wire & Pin Face and Side Cutter .....51  
 Wire & Pin Side Cutter .....51  
 Wire Flat Pliers .....52  
 Wire Seizing Forceps .....52  
 Wire Twisters .....50  
 WOODSON Elevator .....33

**Description Page**

**Y**

YANCOSKIE Abdominoplasty Retractor .....9  
 YANKAUER Suction Tubes .....86

**Z**

Zygomatic Arch Elevator .....22

# Numerical Index

Numerical Index

**0 - 9**

117 - 120



Item	Page	Item	Page	Item	Page	Item	Page	Item	Page	Item	Page	Item	Page
<b>502</b>		509-45520	57	510-40411	59	510-622	55	512-146	66	514-214	75	518-2070	11
502-18015	29	509-45719	57	510-40511	59	510-623	55	512-20015	69	514-215	75	518-240	12
502-18020	29	509-45917	57	510-40616	58	510-624	55	512-20415	68	514-216	75	518-242	12
502-31710	30	509-45920	57	510-407	61	510-625	55	512-20514	62	514-217	75	518-258	13
502-31912	30	509-46021	42	510-409	61	510-630	55	512-23217	68	514-230	75	518-260	13
502-58320	30	509-46221	42	510-410	59	510-700	62	512-23417	68	514-231	75	518-262	13
<b>506</b>		509-5410	59	510-41011	59	510-701	62	512-25602	67	514-232	75	518-370	11
506-0300	86	509-5411	59	510-411	59	510-730	62	512-25612	67	514-233	75	518-372	11
506-0308	86	509-5412	59	510-41111	59	<b>511</b>		512-25802	67	514-234	75	518-373	11
506-3703	86	509-5413	59	510-412	59	511-02217	70	512-25812	67	514-235	75	518-374	11
506-3705	86	509-5415	59	510-413	59	511-039	68	512-3061	71	514-236	75	518-512516	6
506-3707	86	509-5417	59	510-414	59	511-040	68	512-3063	71	514-237	75	518-512525	6
<b>508</b>		509-544218	56	510-41411	59	511-042	68	512-30633	71	514-27118	76	518-5129	6
508-14310	88	509-544318	56	510-415	59	511-044	68	512-3064	71	514-43014	76	518-5130	6
508-14312	88	509-544619	56	510-416	59	511-046	68	512-3065	71	514-43015	76	518-5133	6
508-14315	88	509-544719	56	510-417	59	511-048	68	512-30651	71	514-43016	76	518-5134	6
508-3500	89	<b>510</b>		510-420	60	511-06012	67	512-30655	71	514-43019	76	518-5136	6
508-3501	89	510-014	54	510-421	60	511-06015	67	512-30656	71	514-43023	76	518-5138	6
508-3502	89	510-015	54	510-43212	60	511-06412	66	512-30658	71	514-941	77	518-5142	6
508-3510	89	510-024	54	510-43312	60	511-06415	66	512-3067	71	514-942	77	518-5143	6
508-3600	89	510-025	54	510-43412	60	511-07012	66	512-320	66	514-945	77	518-5144	6
508-3601	89	510-034	54	510-44319	67	511-07015	66	512-321	66	514-960	77	518-5150	5
<b>509</b>		510-035	54	510-44321	67	511-07212	66	512-330	67	514-963	77	518-5151	5
509-02817	54	510-04409	61	510-44323	67	511-07215	66	512-334	67	<b>516</b>		518-5152	5
509-02917	54	510-04410	60	510-44414	56	511-07412	66	512-362	68	516-146	78	518-5153	5
509-03216	54	510-04509	61	510-44418	56	511-07612	66	512-530	66	516-147	78	518-67806	7
509-03316	54	510-04510	60	510-44518	56	511-07615	66	512-540	66	516-14824	78	518-67810	7
509-16011	60	510-082	54	510-44619	56	511-07715	66	512-590	72	516-14924	78	518-67813	7
509-16111	60	510-083	54	510-44719	56	511-1017	68	512-592	72	518-67819	7	518-67815	7
509-17413	54	510-088	54	510-45111	56	511-1018	69	512-640	72	518-67825	7	518-67817	7
509-17911	61	510-110	55	510-45115	56	511-1018	69	512-654	72	<b>518</b>		518-68219	7
509-36018	55	510-111	55	510-45118	56	511-10212	71	512-670	72	518-050	7	518-68225	7
509-36020	55	510-114209	59	510-45123	56	511-10215	71	512-671	72	518-051	7	518-68231	7
509-36023	55	510-114210	59	510-45911	60	511-10312	71	512-720	72	518-052	7	518-68250	7
509-36118	55	510-114309	59	510-46021	42	511-10315	71	512-721	72	518-129	6	518-68275	7
509-36120	55	510-114310	59	510-46022	42	511-10418	71	<b>513</b>		518-1291	6	518-690	7
509-40015	58	510-120	55	510-5082	54	511-10518	71	513-56015	71	518-134	6	518-691	7
509-40218	58	510-121	55	510-5083	54	511-1217	68	513-56018	71	518-136	6	518-692	7
509-40616	58	510-122	55	510-514	54	511-1218	69	513-56115	71	518-138	6	518-80163	14
509-409	61	510-123	55	510-515	54	511-1218	69	513-56118	71	518-142	6	518-872	14
509-410	59	510-124	55	510-516011	60	511-3218	69	513-56118	71	518-143	6	518-873	14
509-411	59	510-125	55	510-516111	60	511-36120	71	513-56118	71	518-144	6	518-890	14
509-412	59	510-160	59	510-517413	54	511-36130	71	<b>514</b>		518-144	6	518-891	14
509-413	59	510-161	59	510-524	54	511-36620	71	514-030	74	518-14410	11	518-930	14
509-415	59	510-163	59	510-525	54	511-36630	71	514-031	74	518-14412	11	518-931	14
509-417	59	510-170	58	510-534	54	511-36820	71	514-032	74	518-14414	11	518-940	14
509-43016	42	510-171	58	510-535	54	511-36830	71	514-033	74	518-14416	11	518-941	14
509-43611	61	510-172	58	510-540616	58	511-4618	68	514-034	74	518-14510	11	518-942	14
509-43711	61	510-173	58	510-5410	59	511-4620	68	514-035	74	518-14512	11	518-943	14
509-43911	62	510-17413	54	510-5411	59	511-4625	68	514-036	74	518-14514	11	518-944	14
509-44016	57	510-17452	67	510-5412	59	<b>512</b>		514-066	74	518-14516	11	518-945	14
509-44218	56	510-18612	67	510-5413	59	512-0016	68	514-067	74	518-150	5	519-18211	14
509-44318	56	510-18712	67	510-5415	59	512-032	66	514-072	74	518-152	5	519-18216	14
509-44418	56	510-18851	70	510-5417	59	512-034	66	514-073	74	518-18415	10	519-18218	14
509-44518	56	510-200	63	510-54218	56	512-036	66	514-076	74	518-18715	10	<b>521</b>	
509-44619	56	510-20012	70	510-545318	56	512-038	66	514-077	74	518-2001	12	521-008	80
509-44619	56	510-201	63	510-545318	56	512-040	66	514-08119	74	518-2002	12	521-010	80
509-44719	56	510-202	63	510-5610	55	512-042	66	514-08123	74	518-2011	12	521-016	80
509-44723	56	510-203	63	510-5620	55	512-044	66	514-090	74	518-2012	12	521-018	80
509-44918	57	510-210	62	510-5621	55	512-046	66	514-091	74	518-2021	12	521-020	80
509-45111	56	510-221	63	510-5622	55	512-049	66	514-100	75	518-2022	12	521-02013	81
509-45115	56	510-222	63	510-5623	55	512-091	66	514-101	75	518-2023	12	521-022	80
509-45118	56	510-30110	55	510-5624	55	512-10217	68	514-1072	78	518-2024	12	521-02215	81
509-45123	56	510-32013	58	510-5625	55	512-10417	68	514-1077	78	518-2025	12	521-02415	81
509-45218	56	510-32812	66	510-5700	62	512-112	68	514-1078	78	518-2033	12	521-02418	81
509-45318	56	510-33011	55	510-5701	62	512-132	66	514-1082	78	518-2035	12	521-02420	81
509-45318	56	510-33111	55	510-580	54	512-134	66	514-1070	78	518-2037	12	521-02423	81
509-45417	57	510-350	54	510-581	54	512-136	66	514-1072	78	518-2040	12	521-030	80
509-45420	57	510-351	54	510-582	54	512-138	66	514-110	75	518-2045	13	521-032	80
509-45517	57	510-36123	55	510-583	54	512-142	66	514-111	75	518-2049	13	521-042	81
		510-390	59	510-583	54	512-144	66	514-210	75	518-2050	12	521-060	82
		510-391	59	510-583	54			514-211	75	518-2064	13	521-06011	82
		510-40015	58	510-610	55			514-212	75	518-2068	13	521-06013	82
		510-402	59	510-611	55			514-213	75	518-2069	13	521-06016	82
				510-620	55								
				510-621	55								
				510-621	55								



Item	Page	Item	Page	Item	Page	Item	Page	Item	Page	Item	Page	Item	Page
521-062	82	524-080RD	63	<b>542</b>		546-1017	13	546-711	44	548-132	40	570-6803	94
521-064	82	524-080WE	63	542-1020	70	546-1018	13	546-712	44	548-133	40	570-6812	94
521-10617	83	524-080YW	63	542-1030	70	546-1020	13	546-713	44	548-134	40	570-6815	94
521-11615	83	<b>532</b>		542-1040	70	546-250	41	546-730	45	548-14015	88	570-6822	94
521-11618	83	532-128214	49	542-1050	70	546-37415	88	546-732	45	548-290	4	570-6823	94
521-11620	83	532-128314	49	542-1300	72	546-40003	34	546-750	44	548-292	4	570-6824	94
521-12414	83	532-95911	50	542-1302	72	546-40004	34	546-75011	72	548-41014	88	570-6833	94
521-12415	83	<b>533</b>		542-1304	72	546-40005	34	546-751	44	548-41016	88	570-6834	94
521-12418	83	533-5281	50	542-1304	72	546-40006	34	546-752	44	548-41114	88	570-7306	93
521-14011	81	533-5282	50	542-1372	64	546-40103	34	546-753	44	548-41116	88	570-7356	93
521-14013	81	533-5283	50	542-1373	64	546-40104	34	546-760	12	548-41214	88	570-7512	93
521-16614	82	533-5284	50	542-1374	64	546-40105	34	546-80015	11	<b>549</b>		570-7513	93
521-22612	82	533-53016	50	542-1375	64	546-40106	34	546-83423	41	549-55025	33	570-7514	93
521-22614	82	533-53216	50	542-1376	64	546-42004	34	546-84023	41	549-56406	34	570-7524	93
521-22617	82	533-53416	50	542-1377	64	546-42005	34	546-84223	41	549-56407	34	570-7525	93
521-22618	82	533-53820	52	542-1378	64	546-440	43	546-84423	41	549-56409	34	570-7535	93
521-22712	82	533-54518	51	542-1379	64	546-5060	44	<b>547</b>		549-56411	34	570-7733	93
521-22714	82	533-54522	51	542-1381	64	546-5061	44	547-20101	46	<b>552</b>		570-7823	95
521-22717	82	533-54618	51	542-1383	64	546-5062	44	547-20102	46	552-010	76	570-7923	95
521-22718	82	533-56814	52	542-1396	64	546-5063	44	547-20195	46	552-014	76	570-7933	95
521-22812	82	<b>534</b>		542-1397	64	546-5064	44	547-25318	42	552-019	76	570-7934	95
521-22814	82	534-3415	69	542-1399	64	546-5065	44	547-25520	42	552-020	76	570-8013	97
521-24614	84	534-3416	69	542-1399	64	546-5066	44	547-33921	43	552-030	76	570-8113	97
521-24714	84	534-3420	69	542-1400	64	546-5067	44	547-34021	43	552-030	76	570-8252	93
521-24814	84	534-3424	69	542-1401	64	546-5068	44	547-37415	88	552-5215	77	570-8253	93
521-24914	84	534-3430	69	542-150	11	546-5068	44	547-40119	33	<b>570</b>		570-9013	97
521-25214	84	534-3615	69	542-152	11	546-5070	44	547-43317	33	570-0010	97	570-9113	97
521-25218	84	534-3616	69	542-940	70	546-53022	33	547-44710	36	570-0012	97	<b>571</b>	
521-25314	84	534-3620	69	542-950	70	546-53416	34	547-4483	35	570-0013	97	571-1153	98
521-25318	84	534-3624	69	<b>543</b>		546-54019	34	547-4631	35	570-0015	97	571-1254	98
521-25614	84	534-3630	69	543-07605	70	546-58016	35	547-4633	35	570-0040	97	571-1256	98
521-25714	84	534-3630	69	543-07610	70	546-58216	35	547-4633	35	570-0050	97	571-1309	98
521-40013	84	534-3630	69	543-07805	70	546-594	33	547-4691	35	570-1203	92	571-2154	98
521-40015	84	534-3624	69	543-07810	70	546-595	33	547-4692	35	570-1303	92	571-2254	98
521-40113	84	534-3630	69	543-07810	70	546-596	33	547-4692	35	570-1304	92	571-2306	98
521-40115	84	534-3815	69	543-14901	70	546-6101	88	547-4693	35	570-1306	92	571-3153	98
521-40213	84	534-3816	69	543-14903	70	546-6102	88	547-4693	35	570-2203	92	571-3156	98
521-40313	84	534-3820	69	543-14903	70	546-6103	88	547-47107	35	570-2303	92	571-3256	98
<b>522</b>		534-3824	69	543-14905	70	546-6141	34	547-47109	35	570-2304	92	<b>572</b>	
522-010	80	534-3824	69	543-14909	70	546-6142	34	547-47110	35	570-2305	92	572-0091	4
522-030	80	534-3830	69	543-14915	70	546-6143	34	547-47110	35	570-2306	92	572-0092	4
522-031	80	534-4016	69	543-14915	70	546-62202	36	547-47110	35	570-3203	92	572-0093	4
522-032	80	534-4020	69	543-21010	70	546-62204	36	547-47111	35	570-3303	92	572-1000	4
522-100	82	534-4024	69	543-22010	70	546-62206	36	547-47111	35	570-3304	92	572-1001	4
522-102	82	534-4030	69	543-22210	70	546-62207	36	547-47518	35	570-3306	92	572-10011	4
522-104	82	534-4900	67	<b>544</b>		546-62208	36	547-4771	35	570-4304	92	572-1002	4
522-106	82	534-4901	67	544-362	69	546-62208	36	547-4772	35	570-4305	92	572-1003	4
522-27612	82	<b>540</b>		544-370	69	546-62209	36	547-47918	35	570-5052	92	572-1004	4
522-27614	82	540-019	32	544-380	69	546-62210	36	547-50318	33	570-5053	92	572-1005	4
522-27616	82	540-020	32	544-76321	32	546-62212	36	547-50418	33	570-5054	92	572-1006	4
522-27618	82	540-021	32	<b>546</b>		546-63410	36	547-5050	44	570-5152	92	572-1007	4
522-27812	82	540-022	32	546-031	40	546-63412	36	547-5221	44	570-5153	92	572-1008	4
<b>524</b>		540-023	32	546-032	40	546-63414	36	547-5222	44	570-5253	92	572-1009	2
524-012	63	540-024	32	546-033	40	546-64002	36	547-5229	44	570-5254	92	572-1010	2
524-014	63	540-025	32	546-034	40	546-64003	36	547-53800	43	570-5305	92	572-10101	2
524-016	63	540-026	32	546-035	40	546-64004	36	547-53801	43	570-5306	92	572-10102	2
524-018	63	540-027	32	546-0351	40	546-64005	36	547-53810	43	570-5307	92	572-10103	2
524-021	63	540-028	32	546-0352	40	546-64006	36	547-53811	43	570-5308	92	572-10104	2
524-021	63	540-028	32	546-0353	40	546-64007	36	547-53820	43	570-5309	92	572-10105	2
524-080	63	540-029	32	546-0354	40	546-64008	36	547-54516	11	570-5310	92	572-10106	2
524-076BK	63	540-030	32	546-041	40	546-64009	36	547-54615	11	570-5311	92	572-10107	2
524-076RB	63	540-050	13	546-042	40	546-64010	36	547-57719	34	570-5312	92	572-10108	2
524-076GB	63	540-051	13	546-043	40	546-64011	36	<b>548</b>		570-6203	93	572-10109	2
524-076GN	63	540-052	13	546-043	40	546-64012	36	548-063	87	570-6303	93	572-10110	2
524-076PK	63	546-07035	40	546-043	40	546-64013	36	548-0631	87	570-6601	94	572-10107	104
524-076RD	63	546-07050	40	546-043	40	546-64014	36	548-063L	87	570-6602	94	572-10108	104
524-076WE	63	546-07075	40	546-043	40	546-64015	36	548-064	87	570-6603	94	572-1011	2
524-076YW	63	546-07090	40	546-043	40	546-64016	36	548-064L	87	570-6611	94	572-1012	2
524-080BK	63	546-07135	40	546-043	40	546-64017	36	548-067	87	570-6612	94	572-10121	2
524-080BK	63	546-07150	40	546-043	40	546-64018	36	548-067L	87	570-6613	94	572-10122	2
524-080RB	63	546-07175	40	546-043	40	546-64019	36	548-067L	87	570-6622	94	572-10127	104
524-080GN	63	546-07190	40	546-043	40	546-64020	36	548-067	87	570-6711	94	572-10128	104
524-080PK	63	546-1010	13	546-043	40	546-64021	36	548-130	40	570-6715	94	572-1013	2
524-080RD	63	546-1016	13	546-043	40	546-64022	36	548-131	40	570-6721	94	572-10187	104
				546-043	40	546-64023	36			570-6802	94	572-10188	104



<b>Item</b>	<b>Page</b>
672-1660	23
672-1661	23
672-1662	23
672-1663	24
672-1664	24
672-1665	24
672-1666	24
672-1667	24
672-1668	24
672-1669	24
672-1670	24